

	230 or 400 VAC 50/60 Hz	I max			
<b>6 460 20</b>	2P+E	16 A	x 8	-	-
<b>6 460 21</b>	2P+E	32 A	x 16	-	x 2
<b>6 460 22</b>	2P+E	16 A	x 21	x 3	-
<b>6 460 23</b>	2P+E	32 A	x 21	x 3	x 3
<b>6 460 24</b>	3P+N+E	16 A	x 21	x 3	-
<b>6 460 25</b>	2P+E	10 A	x 16	-	-

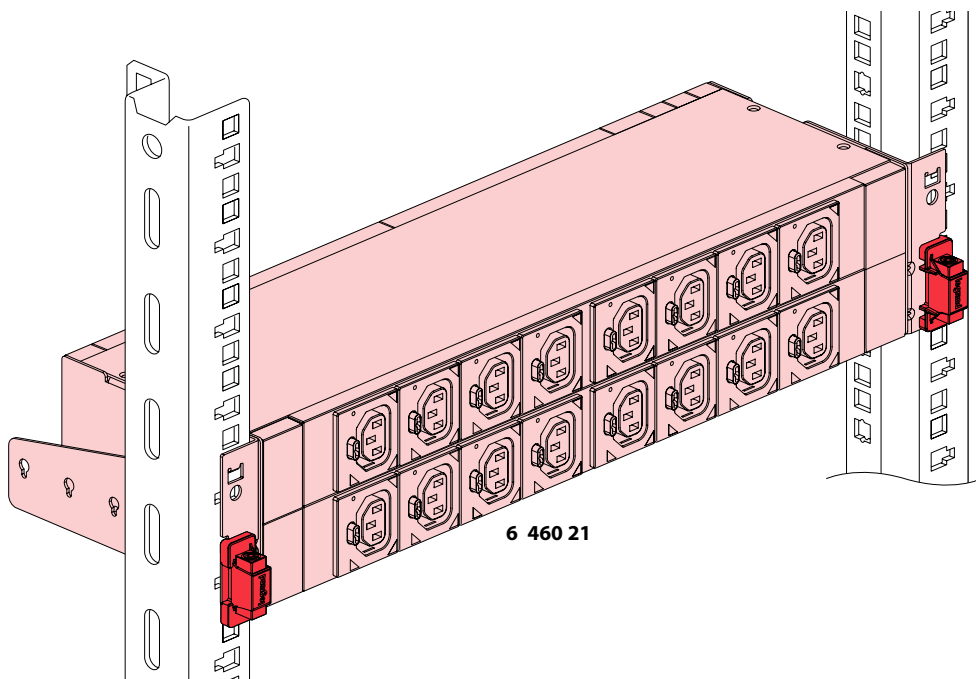

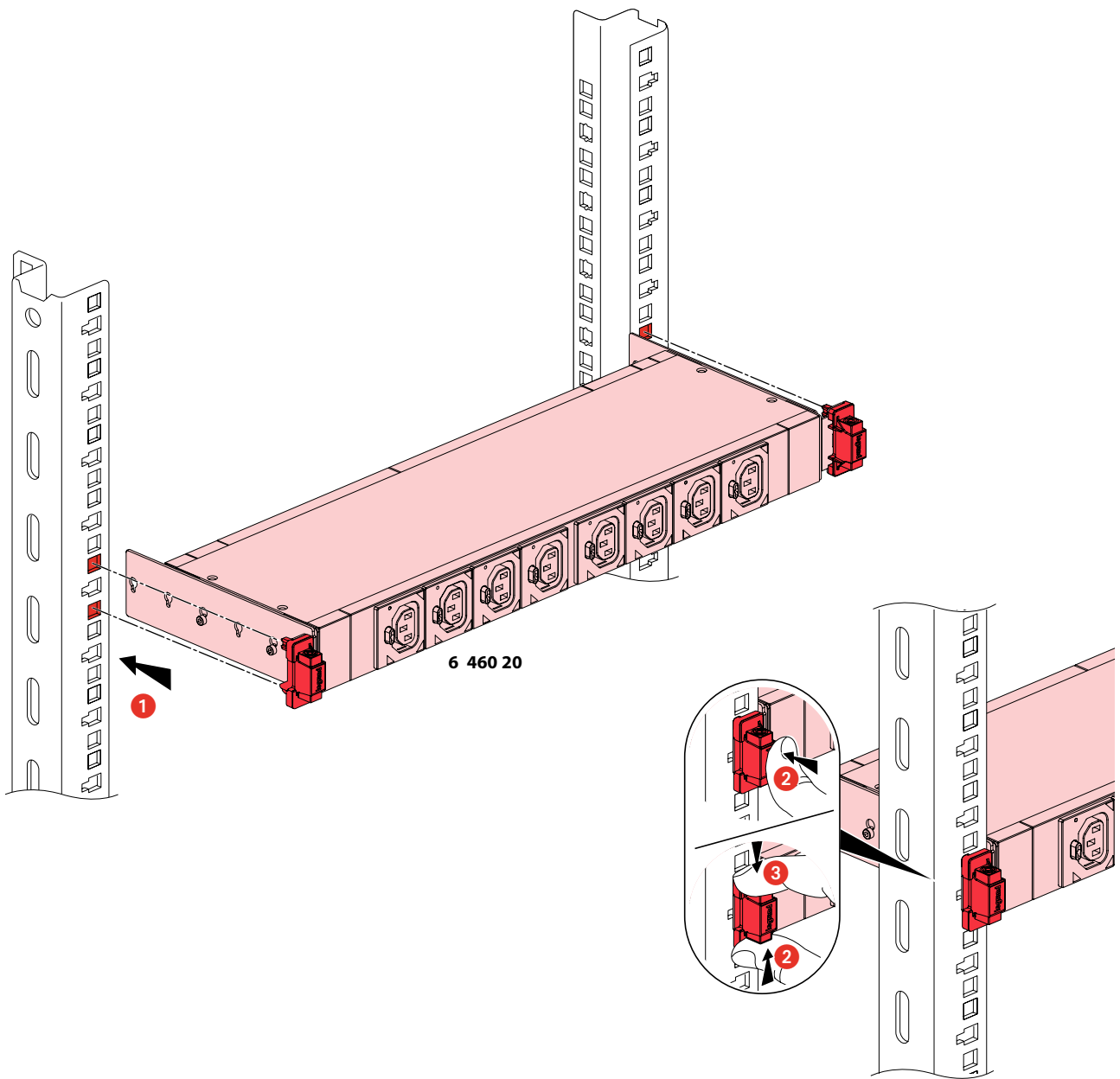

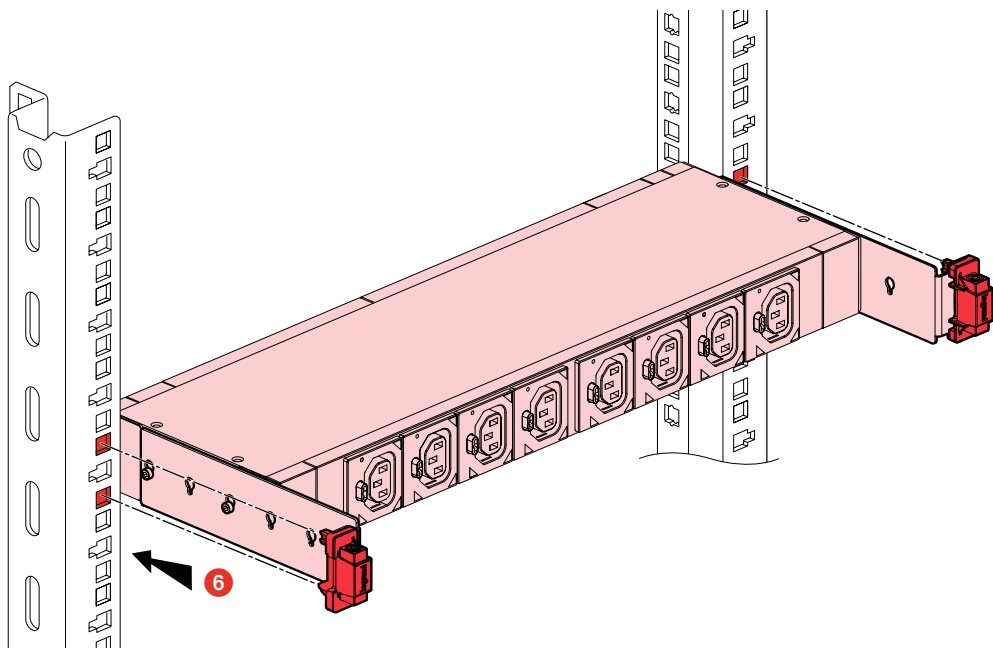

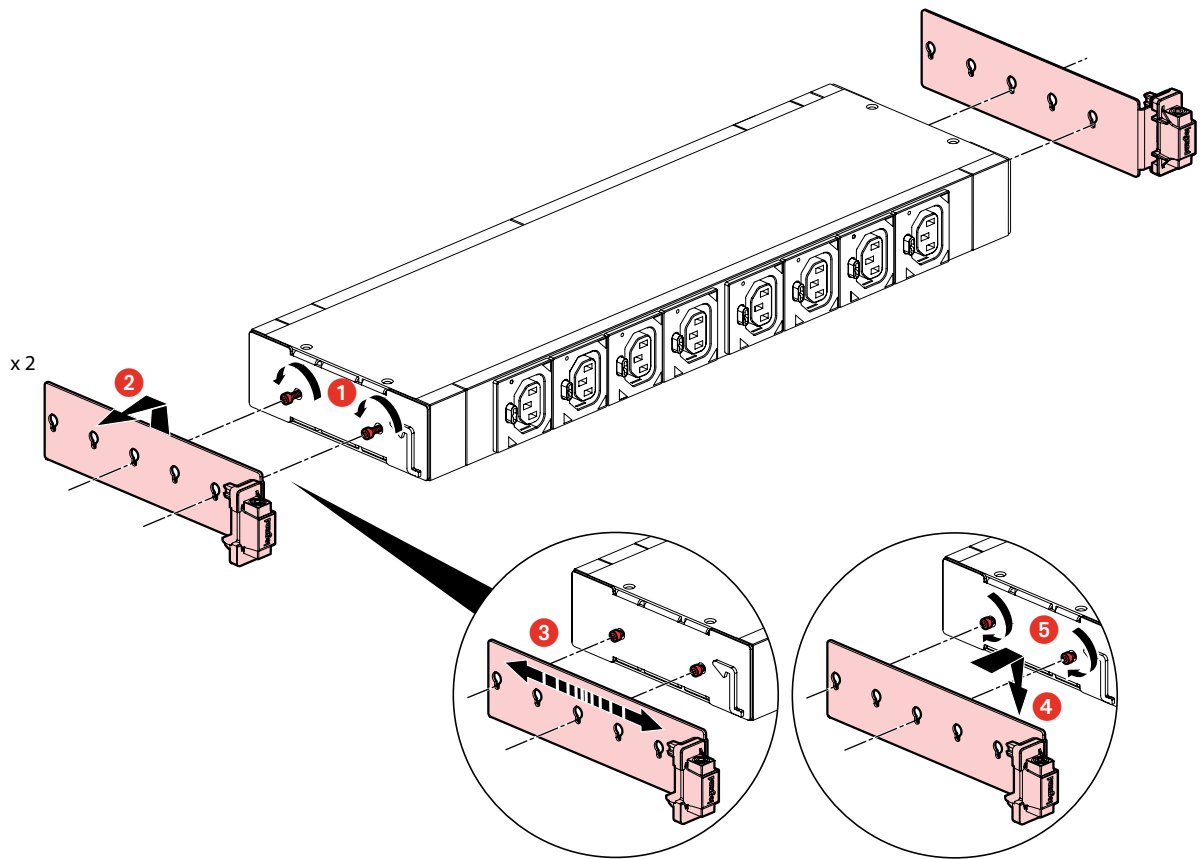
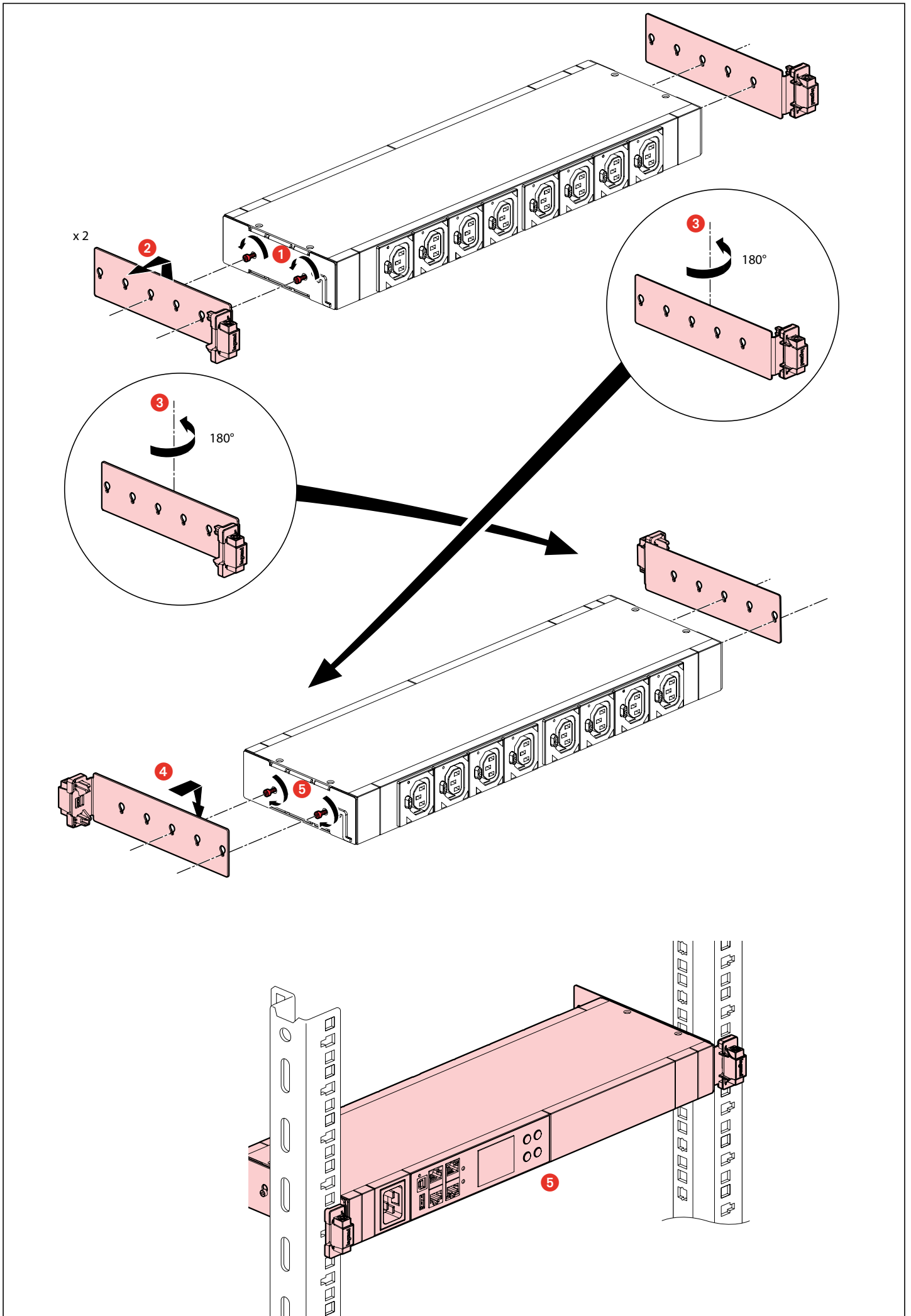
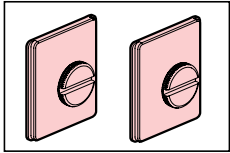

6 460 22/23/24/25

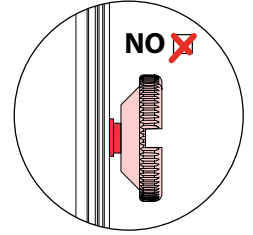
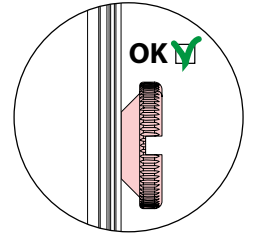
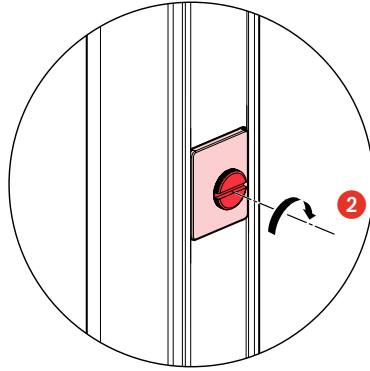
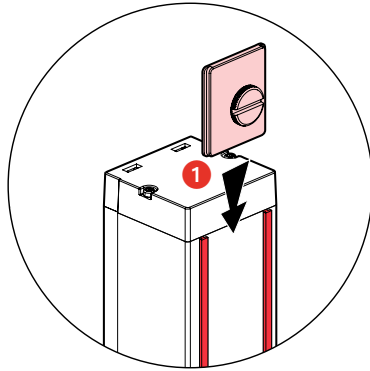

0 463 18/19/21/22/23/28/29  
0 463 30/33/41/42/43/85/86

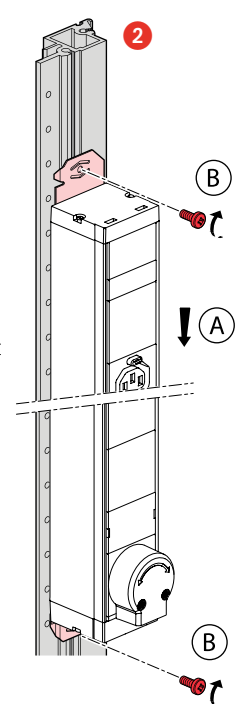
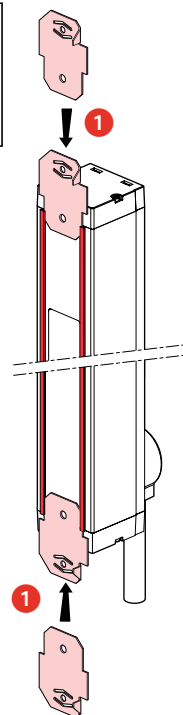
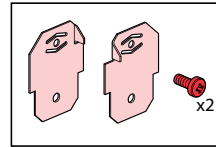
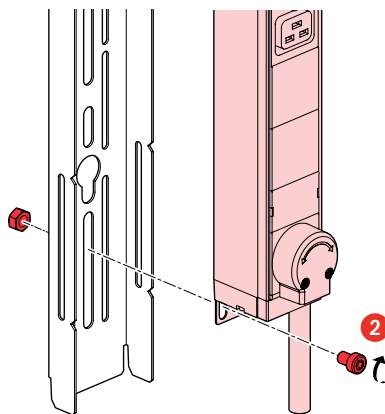
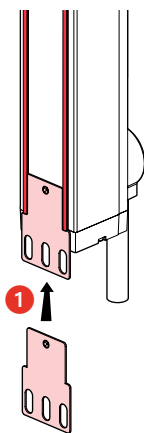
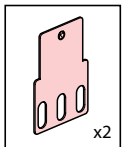
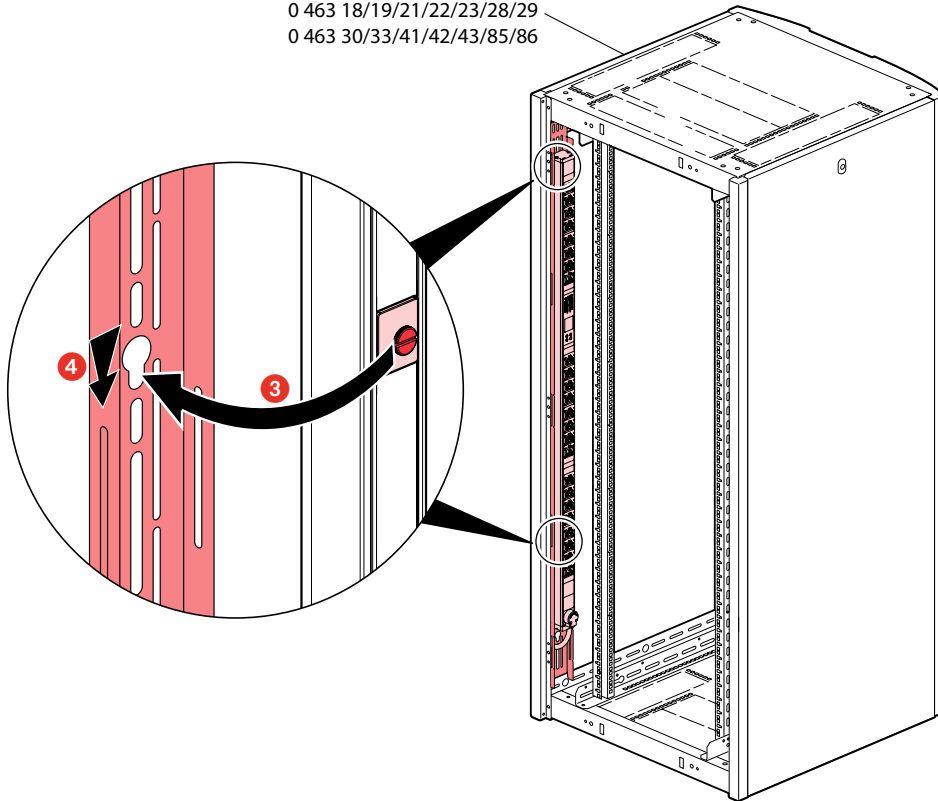

### Warning

This is a class A product. In a domestic environment this product may cause radio interference in which case the user may be required to take adequate measures.



### 0U PDU Overview

6 460 23

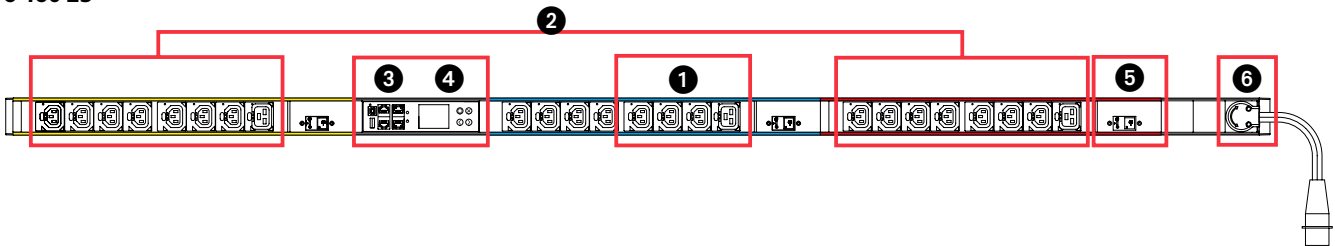

- 1 Outlets switched
- 2 Circuits
- 3 Controller with Connector Ports: See **Controller** (on page 7).
- 4 Front Panel Display: See **Front Panel Display** (on page 8).
- 5 Circuit Breakers
- 6 Inlet

### 1U PDU Overview

6 460 20

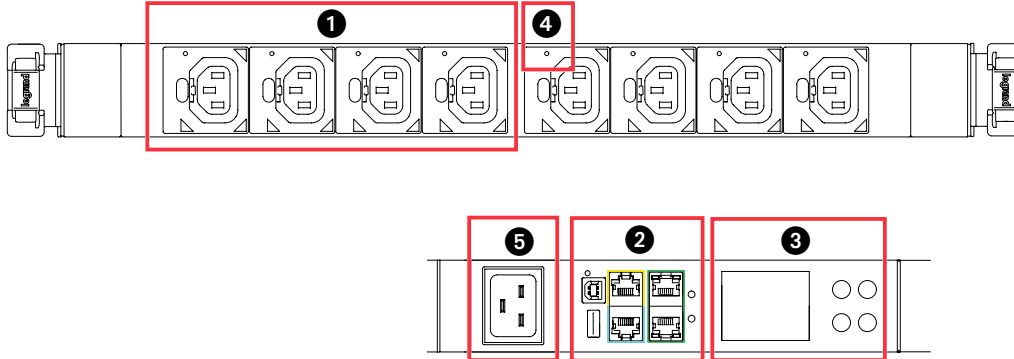

- 1 Outlets: Front of PDU
- 2 Controller with Connector Ports: See **Controller** (on page 7).
- 3 Front Panel Display: See **Front Panel Display** (on page 8).
- 4 LED indicator
- 5 Inlet: Rear of PDU

### Power On the PDU

Verify that all circuit breakers on the Legrand PDU device are set to ON. If not, turn them ON.

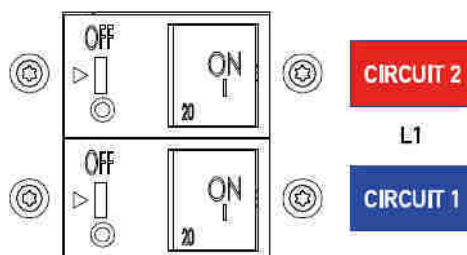

Connect each Legrand PDU to an appropriately rated branch circuit. See the label or nameplate affixed to your Legrand PDU for appropriate input ratings or range of ratings.

Examples

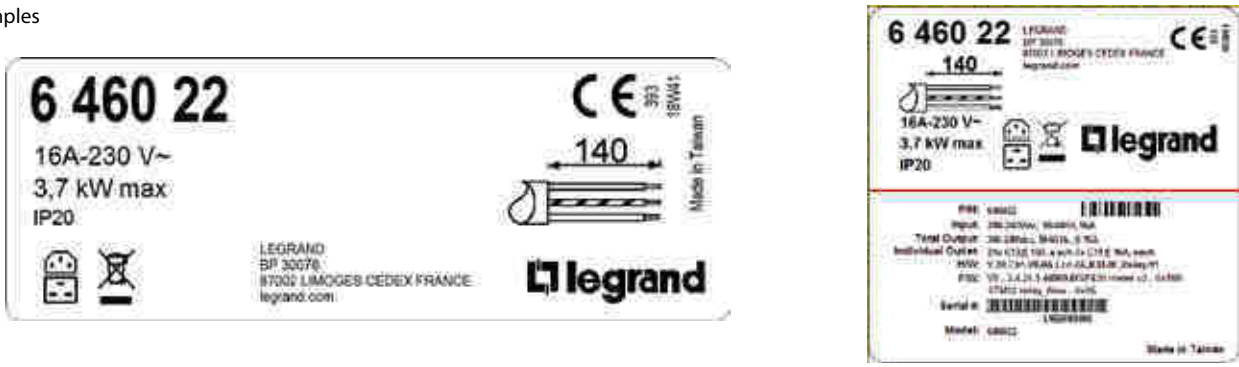

Wait a few moments for the power-on self test and software loading. When complete, the front panel illuminates.

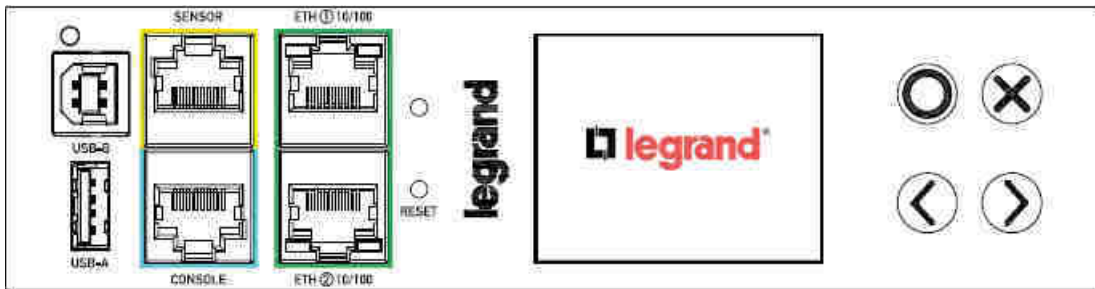

Controller

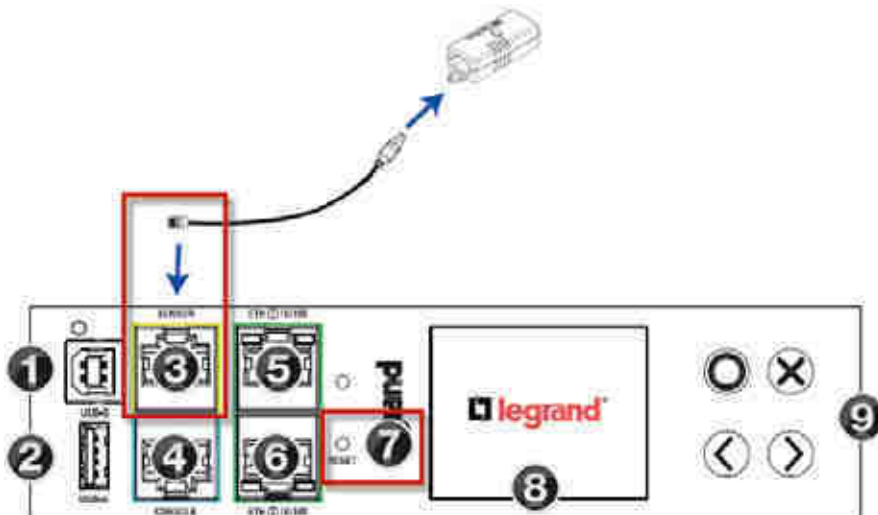

- ❶ USB-B - Cascade devices to share a network connection.
  - Establish a USB connection to a computer for CLI use or disaster recovery.
- ❷ USB-A - Powered USB 2.0 port.
  - Cascade devices to share a network connection.
  - Connect a USB device, such as a Logitech webcam or wireless LAN adapter.
- ❸ Sensor Port - RJ-45 connector.
  - If you have optional environmental sensors or a hub, connect here. DPX3-T1H1 shown here. Some sensors require an RJ-45 adapter.
  - See Set Thresholds on Sensors (on page 10) for details on setting up your sensors for alerts.
- ❹ Console Port - RJ-45 connector.
  - Establish a serial connection to a computer.
- ❺ ETH1 & ETH2 10/100 Ports- Use either Ethernet port for network connection or cascading.
  - Supports up to 100Mbps.
- ❻ ETH2 & ETH2 10/100 Port LEDs - Green LED: physical link and activity.
  - Yellow LED: communications at 10/100 BaseT speeds.
- ❼ Reset Button - Pinhole reset button.
  - Resets to factory defaults when a serial connection is present.
  - Restarts the PDU software without loss of power to outlets when serial connection is not present.
- ❽ Front Panel Display - View PDU and outlet information.
  - Switch outlets on models with switching.
  - View alerts.
- ❾ Control Buttons for Front Panel Display

## Front Panel Display

Use the front panel display buttons to access information about your PDU in the display.

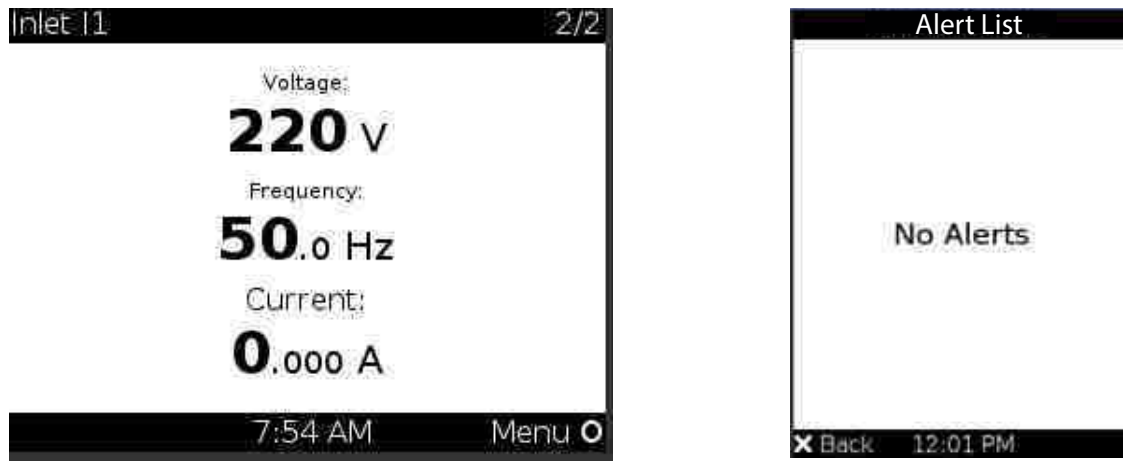

Automatic mode shows inlet pages, or alerts when they are present.  
Scroll with arrow buttons to view all pages, indicated in top right corner.



Scroll with arrow buttons to select items in menu.  
Check the bottom corners for available operations on each page.



When alerts are present, display color is yellow or red.  
Display is red when any critical level alerts are present.

## Connect to the Network :

### Wired Connections:

Connect the PDU ETH1 or ETH2 to your LAN using standard network patch cables.

When connecting both ETH1 and ETH2 ports to your LAN, ensure that each connection is made to a different subnet.

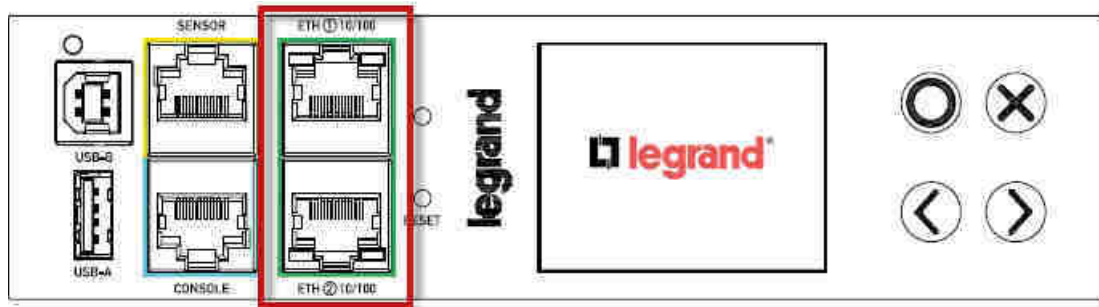

### Wireless Connections:

Connect a supported USB wireless LAN adapter to the PDU USB-A port. OR: Connect a USB hub to the PDU USB-A port, then plug the supported USB wireless LAN adapter

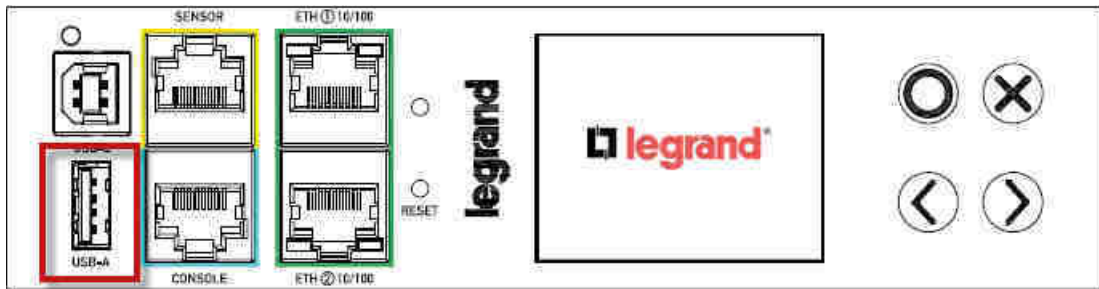

### Supported Wireless LAN Adapters and Configuration:

Network type: 802.11 A/B/G/N

Protocol: WPA2 (RSN) • Key management: WPA-PSK, or WPA-EAP with PEAP and MSCHAPv2 authentication

Encryption: CCMP (AES)

Wi-Fi LAN adapters	Supported 802.11 protocols
SparkLAN WUBR-508N	A/B/G/N
Proxim Orinoco 8494	A/B/G
Zyxel NWD271N	B/G
Edimax EW-7722UnD	A/B/G/N
TP-Link TL-WDN3200 v1	A/B/G/N
Raritan USB WIFI	A/B/G/N

### Login to Web Interface

Use a supported web browser to go to the IP address of the PDU. You can retrieve the IP address from the LED display: Menu > Device Info > ETH1 or ETH2 page.

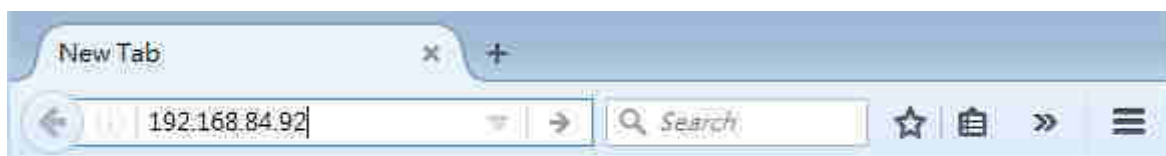

Default Login: admin/legrand

### Supported Web Browsers

Internet Explorer® 11

Firefox® 52 and later

Safari® (Mac)

Google® Chrome® 52 and later

Android 4.2 and later

iOS 7.0 and later

## Web Interface Overview

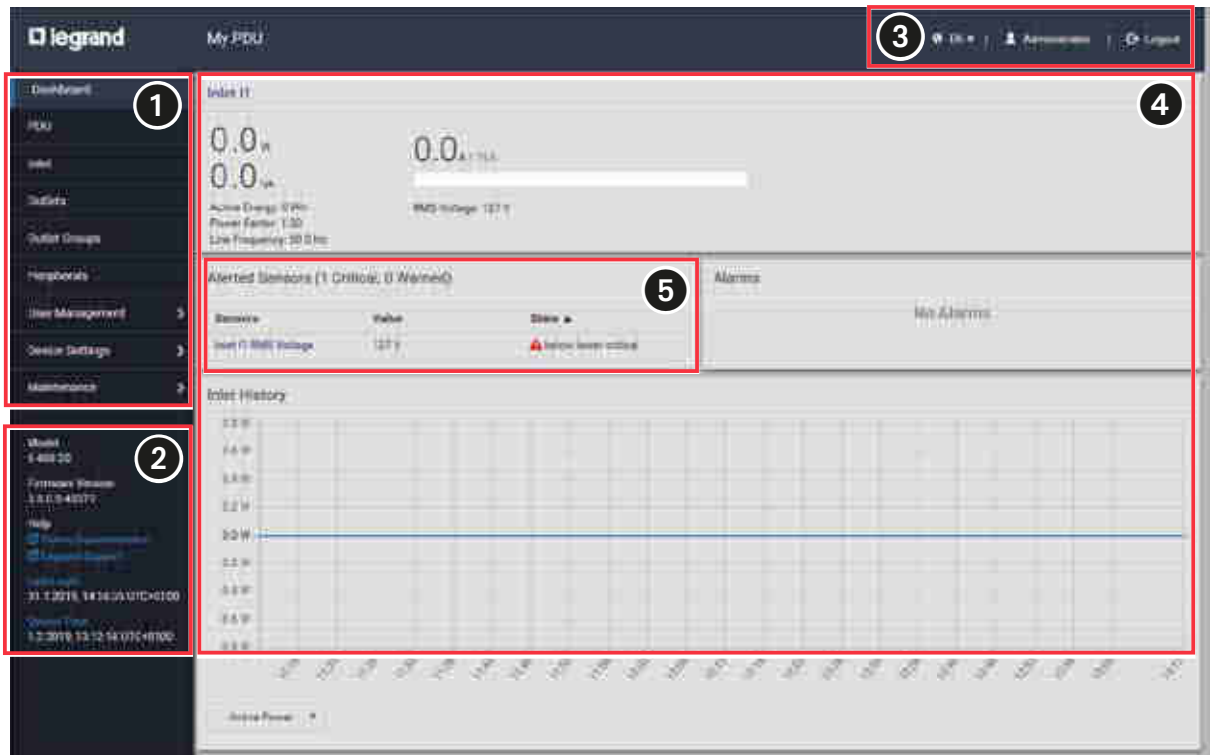

- 1 Menu - Click a Menu item to go to that page. Your menu items may vary based on your PDU model and accessories.
- 2 Info area - Model number
  - Firmware version
  - Help links: Click to go to online help and technical support.
  - Your last login date and time: Click to go to login history.
  - Device Time: Click to go to device time settings.
- 3 User Name and Logout - Logged in username
  - Click to logout.
- 4 Dashboard - This example shows the Dashboard page to view Inlet readings, Alerts, Alarms, Inlet History. Your dashboard may vary based on your PDU model.
- 5 Alerted Sensors
  - When internal or environmental sensors enter a warning or critical state, the Alerted Sensors appear here until they are cleared. Click to go to details.
  - You can set thresholds for these alerts (see "**Set Thresholds on Sensors**" on page 10).

### Set Thresholds on Sensors

If you have optional environmental sensors, follow these tips for web configuration.

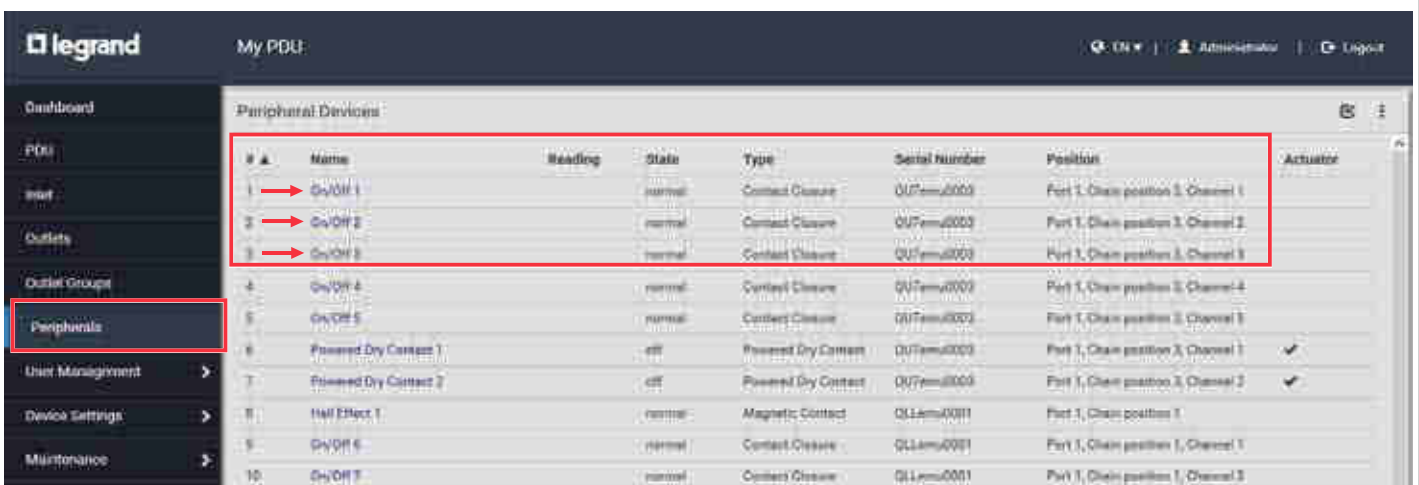

Click Peripherals in the Menu to view your connected external sensors.

Numeric sensors, such as temperature and humidity sensors, have threshold values that control when alerts appear. Alerts appear in the Dashboard and the LED display of your PDU.

Click the Name to configure. When the sensor page opens, click Edit Thresholds.

## Individual Outlet Pages

An outlet's data/setup page is opened after clicking the outlet's name on the Outlets overview page.



# ▲	Name
1	Outlet 1
2	Outlet 2
3	Outlet 3
4	Outlet 4

The individual outlet's page shows this outlet's detailed information



In addition, you can perform the following operations on this outlet page. Note that only outlet-switching capable models show the power-control buttons, and you must have the Switch Outlet permission to perform outlet-switching operations. Therefore, only Legrand Switched PDUs support the following power-control operation.

### To power control this outlet:

- 1 Click one of the power-control buttons.

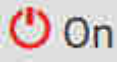

Details	
Label	1
Outlet Status	on
Receptacle Type	IEC 60320 C19
Lines	L1-NEUTRAL
Inlet	Inlet I1
Overcurrent Protector	Overcurrent Protector C1

Button/command	Action
	Power ON.
	Power OFF.
	Power cycle. <ul style="list-style-type: none"><li>▪ Power cycling the outlet(s) turns the outlet(s) off and then back on.</li></ul>

- 2 Confirm it on the confirmation message.



Use the default threshold values, or clear the checkbox to configure your own threshold values. Clear the checkboxes for any alert levels you don't want. All sensors provide upper and lower warning and critical levels.

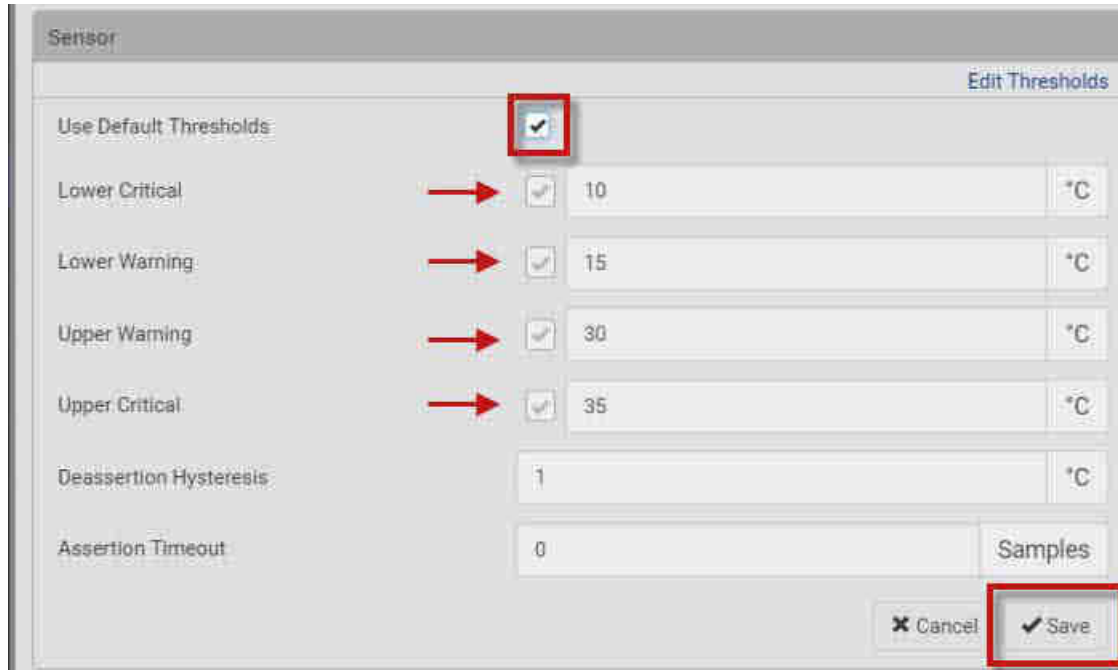

#### Additional Information

Legrand PDU Support page: <https://www.raritan.com/support/product/lg>

Legrand PDU Online Help: <http://help.raritan.com/lg/v3.5.0/en/>

For more details on sensors, download the Environmental Sensors and Actuators Guide from the Support page: <https://www.raritan.com/support/product/lg/>

#### ⚠️ Consignes de sécurité (FR) (LU) (BE) (CH)

Avant toute intervention, couper le courant.  
Respecter strictement les conditions d'installation et d'utilisation.

#### ⚠️ Veiligheidsvoorschriften (NL) (BE)

Onderbreek voor enige ingreep de stroom.  
Neem de installatie- en gebruiksvoorwaarden nauwgezet in acht.

#### ⚠️ Safety instructions (GB) (IE)

Make sure the power supply is disconnected before any intervention.  
Strictly comply with instructions for installation and use.

#### ⚠️ Sicherheitshinweise (DE) (CH)

Vor jeglichem Eingriff die Spannungsfreiheit sicherstellen.  
Einbau- und Gebrauchsanleitungen sind genau zu beachten.

#### ⚠️ Consignes de seguridad (ES)

Antes de realizar cualquier intervención, cortar la corriente eléctrica.  
Respetar estrictamente las condiciones de instalación y uso.

#### ⚠️ Instruções de segurança (PT)

Antes de qualquer intervenção, desligar a corrente.  
Respeitar rigorosamente as condições de instalação e de utilização.

#### ⚠️ Συστάσεις ασφαλείας (GR) (CY)

Πριν από οποιαδήποτε επέμβαση, διακόψτε την παροχή ρεύματος.  
Να τηρείτε αναστρά τας συνθήκες εγκατάστασης και χρήσης.

#### ⚠️ Меры предосторожности (RU)

Отключить питание перед проведением любых ремонтных работ.  
Строго соблюдайте требования к условиям монтажа и эксплуатации

#### ⚠️ Güvenlik talimatları (TR) (CY)

Herhangi bir müdahaleden önce, akımı kesiniz.  
Yerleştirme ve kullanım koşullarına titizlikle riayet ediniz.

#### ⚠️ 安全提示

在任何干涉以前一定要断电，严格遵守安全  
和使用的规定。

إرشادات الأمان: ⚠️

«اقطع التيار الكهربائي قبل أي تدخل. تفيداً تفيداً  
تماماً بشروط التركيب والاستخدام.»