

6 460 12/13/14/15

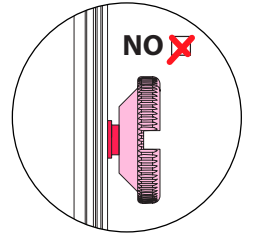

0 463 18/19/21/22/23/28/29
0 463 30/33/41/42/43/85/86

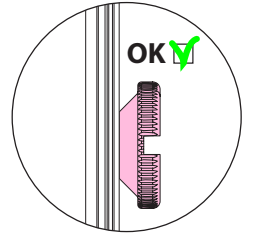
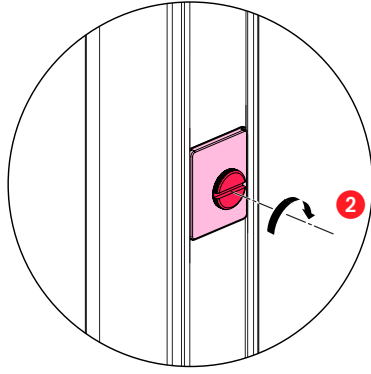
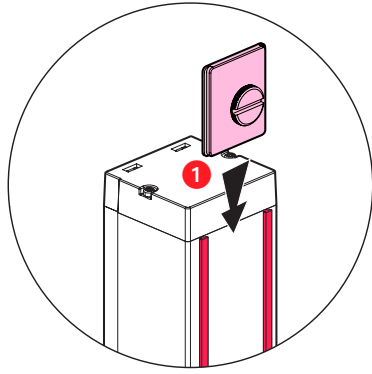
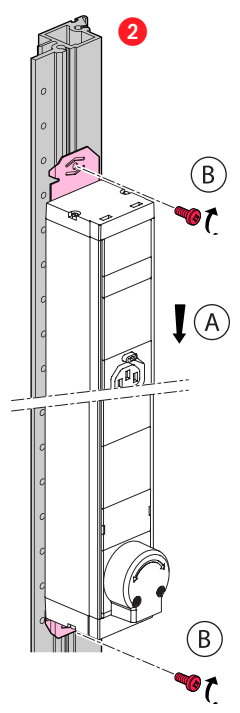
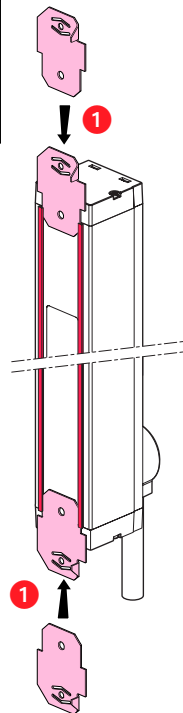
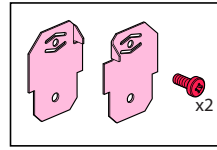
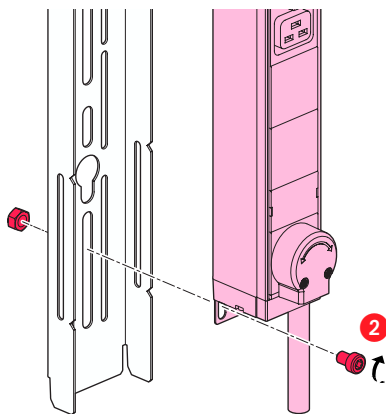
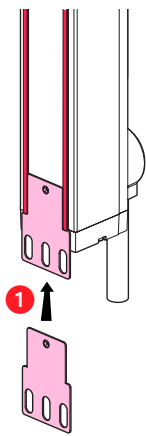
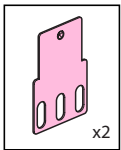
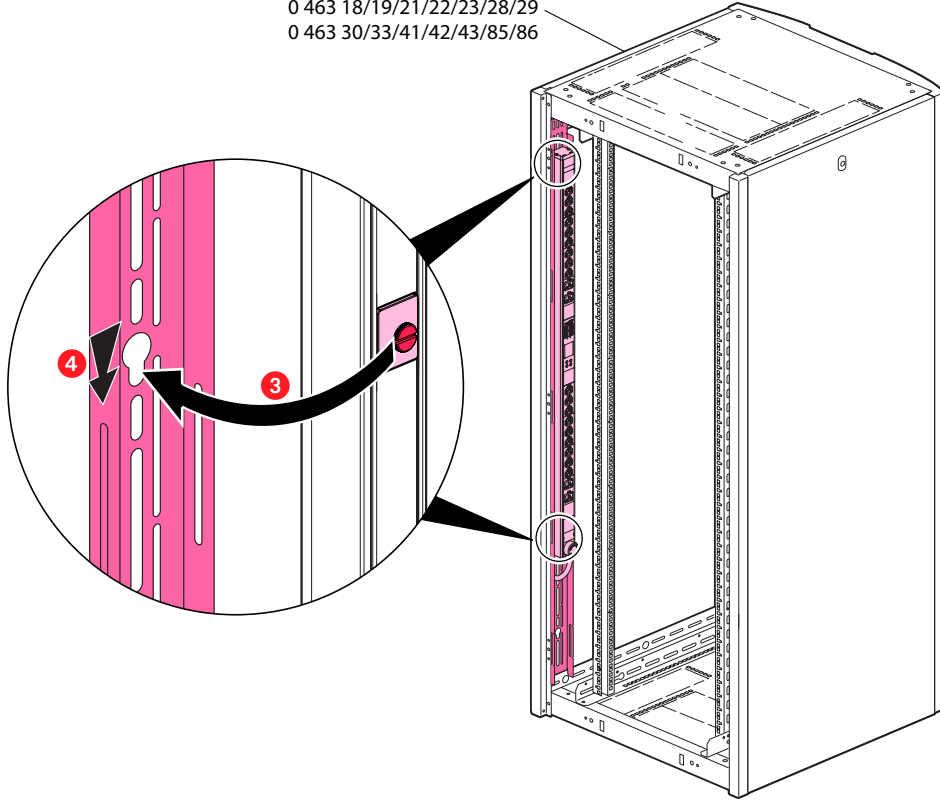

Warning

This is a class A product. In a domestic environment this product may cause radio interference in which case the user may be required to take adequate measures.



0U PDU Overview

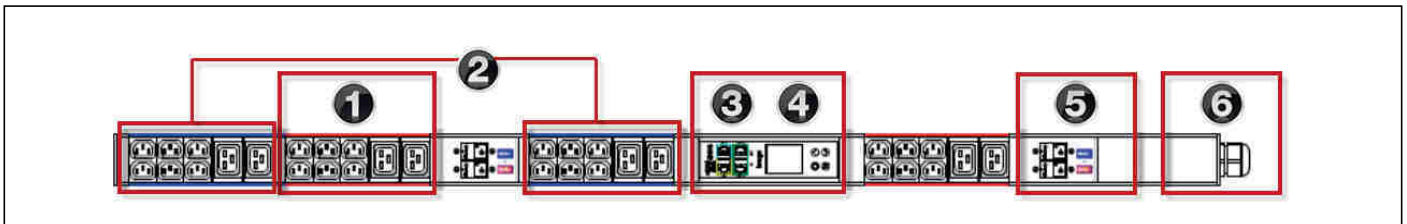

- 1 Outlets
- 2 Circuits
- 3 Controller with Connector Ports: See **Controller** (on page 7).
- 4 Front Panel Display: See **Front Panel Display** (on page 8).
- 5 Circuit Breakers
- 6 Inlet

1U PDU Overview

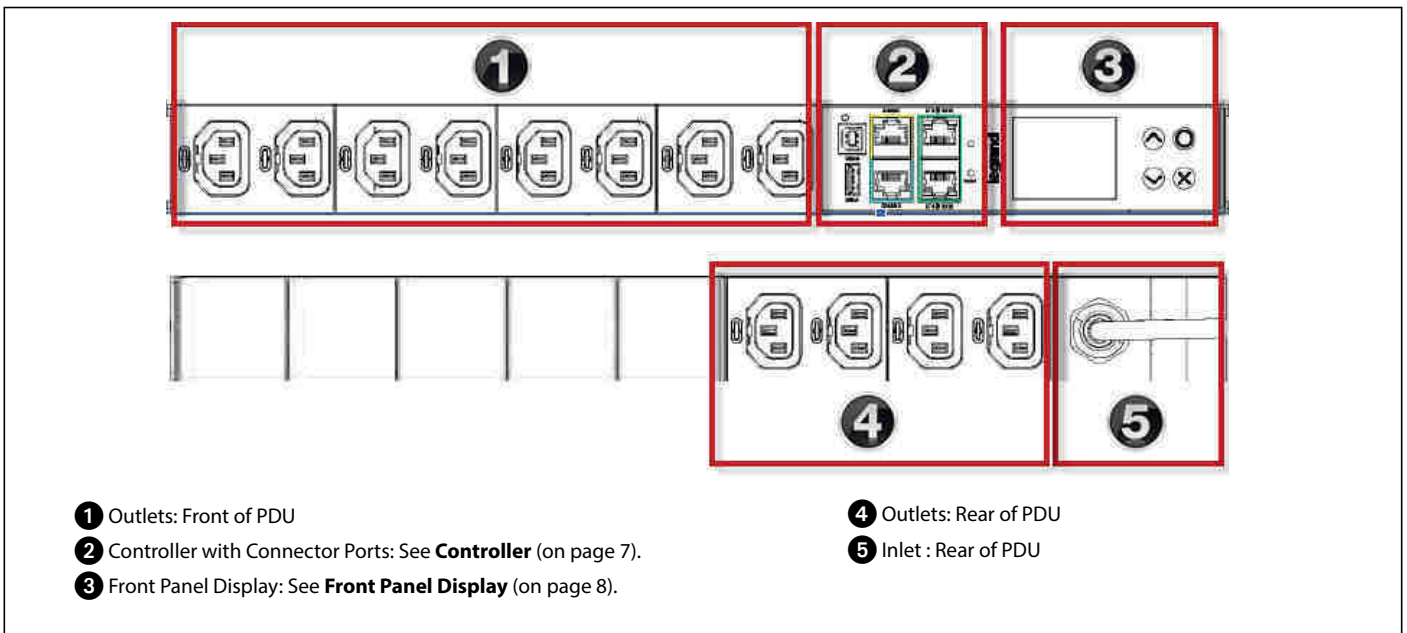

- 1 Outlets: Front of PDU
- 2 Controller with Connector Ports: See **Controller** (on page 7).
- 3 Front Panel Display: See **Front Panel Display** (on page 8).
- 4 Outlets: Rear of PDU
- 5 Inlet : Rear of PDU

Power On the PDU

Verify that all circuit breakers on the Legrand PDU device are set to ON. If not, turn them ON.

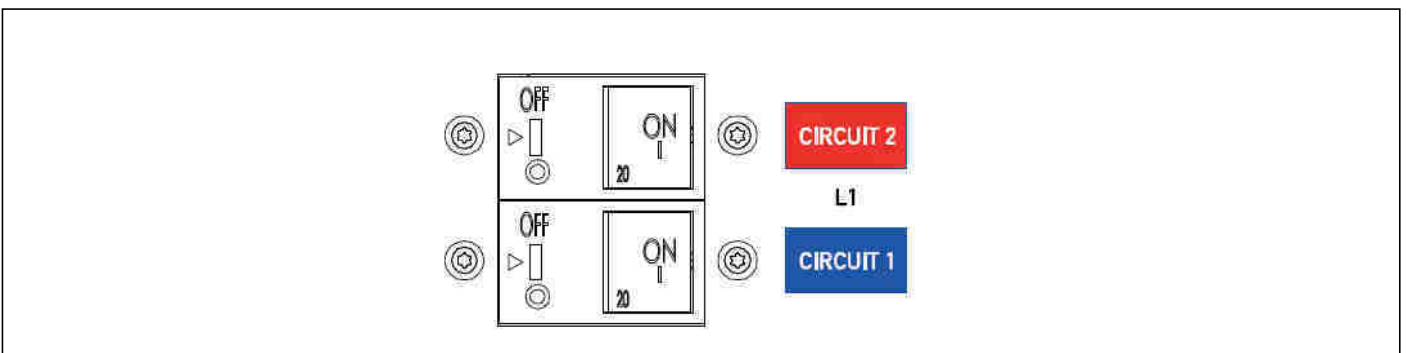

Connect each Legrand PDU to an appropriately rated branch circuit. See the label or nameplate affixed to your Legrand PDU for appropriate input ratings or range of ratings.

Examples



or



Wait a few moments for the power-on self test and software loading. When complete, the front panel illuminates.

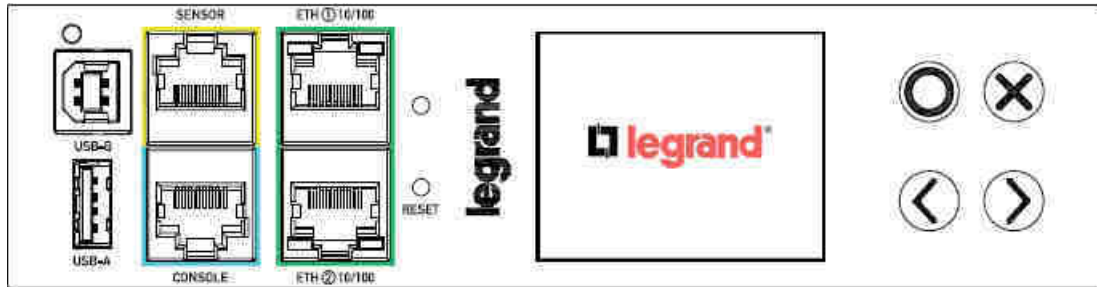

Controller

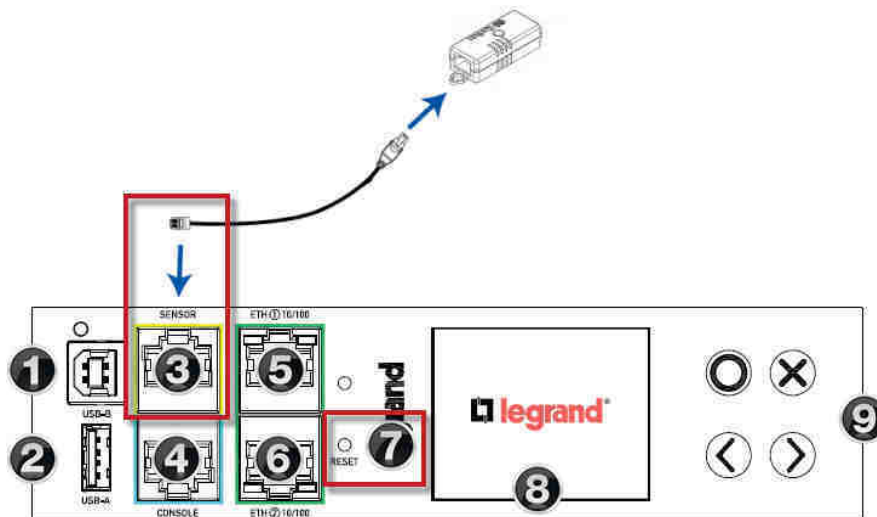

- 1 USB-B - Cascade devices to share a network connection.
 - Establish a USB connection to a computer for CLI use or disaster recovery.
- 2 USB-A - Powered USB 2.0 port.
 - Cascade devices to share a network connection.
 - Connect a USB device, such as a Logitech webcam or wireless LAN adapter.
- 3 Sensor Port - RJ-45 connector.
 - If you have optional environmental sensors or a hub, connect here. DPX3-T1H1 shown here. Some sensors require an RJ-45 adapter.
 - See Set Thresholds on Sensors (on page 10) for details on setting up your sensors for alerts.
- 4 Console Port - RJ-45 connector.
 - Establish a serial connection to a computer.
- 5 ETH1 10/100 Port - Use either Ethernet port for network connection or cascading.
 - Supports up to 100 Mbps.
- 6 ETH2 10/100 Port - Green LED: physical link and activity.
 - Yellow LED: communications at 10/100 BaseT speeds.
- 7 Reset Button - Pinhole reset button.
 - Resets to factory defaults when a serial connection is present.
 - Restarts the PDU software without loss of power to outlets when serial connection is not present.
- 8 Front Panel Display
 - View PDU and outlet information.
 - Switch outlets on models with switching.
- 9 Control Buttons for LED Display
 - View alerts.

Front Panel Display

Use the front panel display buttons to access information about your PDU in the display.

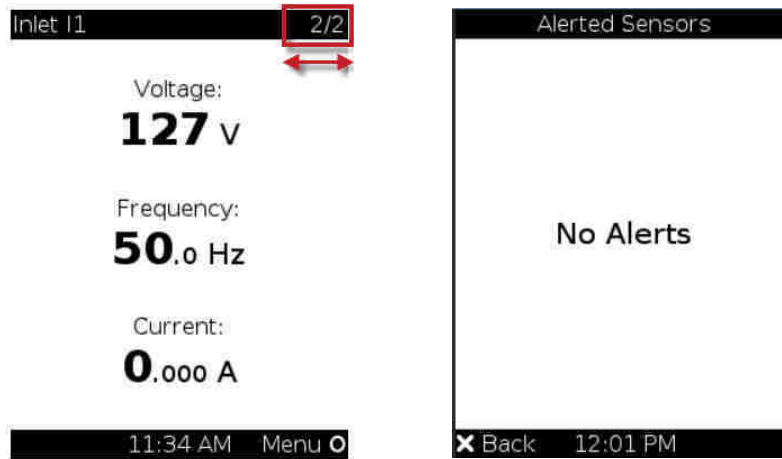

Automatic mode shows inlet pages, or alerts when they are present.
Scroll with arrow buttons to view all pages, indicated in top right corner.

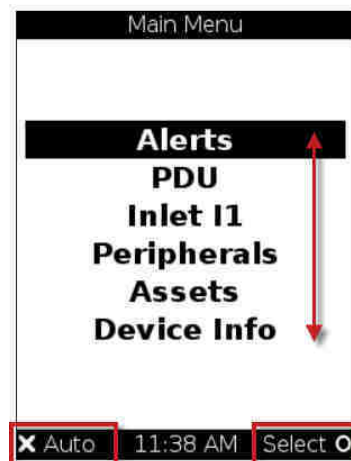

Scroll with arrow buttons to select items in menu.
Check the bottom corners for available operations on each page.

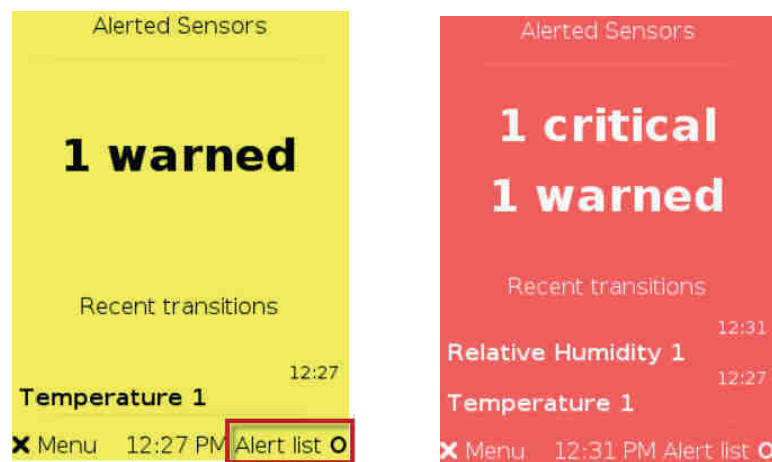

When alerts are present, display color is yellow or red.
Display is red when any critical level alerts are present.

Connect to the Network :

Wired Connections:

Connect the PDU ETH1 or ETH2 to your LAN using standard network patch cables.
When connecting both ETH1 and ETH2 ports to your LAN, ensure that each connection is made to a different subnet.

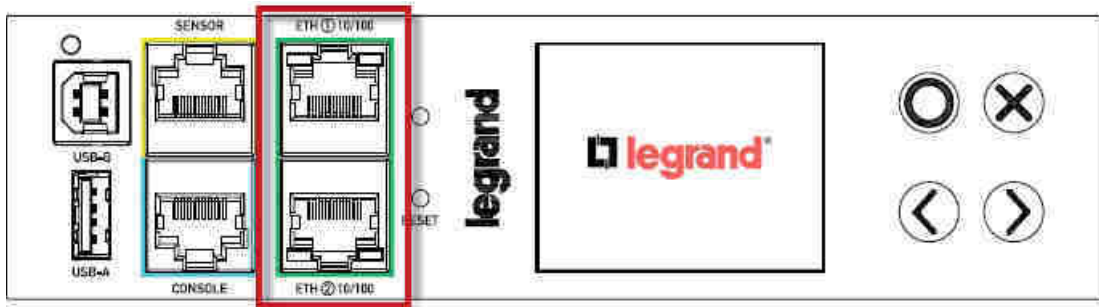

Wireless Connections:

Connect a supported USB wireless LAN adapter to the PDU USB-A port. OR: Connect a USB hub to the PDU USB-A port, then plug the supported USB wireless LAN adapter

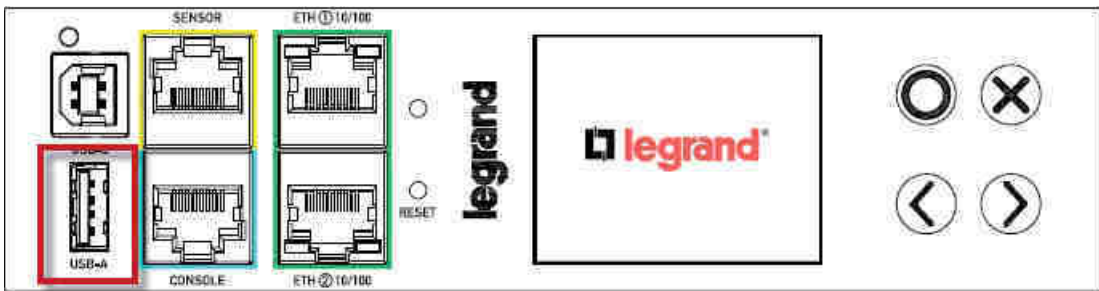

Supported Wireless LAN Adapters and Configuration:

Network type: 802.11 A/B/G/N
Protocol: WPA2 (RSN) • Key management: WPA-PSK, or WPA-EAP with PEAP and MSCHAPv2 authentication
Encryption: CCMP (AES)

Wi-Fi LAN adapters	Supported 802.11 protocols
SparkLAN WUBR-508N	A/B/G/N
Proxim Orinoco 8494	A/B/G
Zyxel NWD271N	B/G
Edimax EW-7722UnD	A/B/G/N
TP-Link TL-WDN3200 v1	A/B/G/N
Raritan USB WIFI	A/B/G/N

Note: To use the Edimax EW-7722UnD or Raritan USB WIFI wireless LAN adapter to connect to an 802.11n wireless network, the handshake timeout setting must be changed to 500 or greater, or the wireless connection will fail.

Login to Web Interface

Use a supported web browser to go to the IP address of the PDU. You can retrieve the IP address from the LED display: Menu > Device Info > ETHERNET page.



Default Login: admin/raritan

Supported Web Browsers

- Internet Explorer® 11
- Microsoft Edge • Firefox® 52 and later
- Safari® (Mac)
- Google® Chrome® 52 and later
- Android 4.2 and later
- iOS 7.0 and later

Web Interface Overview

The screenshot shows the Legrand web interface for 'My PDU'. The sidebar menu (1) includes Dashboard, PDU, Inlet, Outlets, Peripherals, Asset Strip, User Management, Device Settings, and Maintenance. The info area (2) displays Model 6 460 12, Firmware Version 3.4.20.5-0, and last login details. The user name 'Administrator' and 'Logout' button (3) are in the top right. The main dashboard (4) shows Inlet I1 readings: 0.0 W, 0.0 VA, and 0.0 A / 16A. It also displays Active Energy, Power Factor, Line Frequency, and RMS Voltage. The Alarmed Sensors (5) table shows Relative Humidity 1 at 42% (Warning) and Temperature 1 at 24.0 °C (Warning). The Alarms section shows 'No Alarms'. The Inlet History section contains a line graph showing power consumption over time.

- 1 Menu - Click a Menu item to go to that page. Your menu items may vary based on your PDU model and accessories.
- 2 Info area - Model number
 - Firmware version
 - Help links: Click to go to online help and technical support.
 - Your last login date and time: Click to go to login history.
 - Device Time: Click to go to device time settings.
- 3 User Name and Logout - Logged in username
 - Click to logout.
- 4 Dashboard - This example shows the Dashboard page to view Inlet readings, Alerts, Alarms, Inlet History. Your dashboard may vary based on your PDU model.
- 5 Alarmed Sensors
 - When internal or environmental sensors enter a warning or critical state, the Alarmed Sensors appear here until they are cleared. Click to go to details.
 - You can set thresholds for these alerts. See **Thresholds** (see "**Set Thresholds on Sensors**" on page 10).

Set Thresholds on Sensors

If you have optional environmental sensors, follow these tips for web configuration.

The screenshot shows the 'Peripheral Devices' page in the Legrand web interface. The 'Peripherals' menu item in the sidebar is highlighted. The table below lists the connected devices:

#	Name	Reading	State	Type	Position	Actuator
1	Temperature 1	24.0 °C	normal	Temperature	Port 1, Chain Position 5	
2	Relative Humidity 1	42 %	normal	Humidity	Port 1, Chain Position 5	
3	Temperature 2	24.0 °C	normal	Temperature	Port 1, Chain Position 6	
4	Hall Effect 1		normal	Door Contact	Port 1, Chain Position 1	
5	On/Off 1		normal	Contact Closure	Port 1, Chain Position 1, Channel 1	
6	On/Off 2		normal	Contact Closure	Port 1, Chain Position 1,	

Click Peripherals in the Menu to view your connected external sensors. Numeric sensors, such as temperature and humidity sensors, have threshold values that control when alerts appear. Alerts appear in the Dashboard and the LED display of your PDU. Click the Name to configure. When the sensor page opens, click Edit Thresholds.



Use the default threshold values, or clear the checkbox to configure your own threshold values. Clear the checkboxes for any alert levels you don't want. All sensors provide upper and lower warning and critical levels.

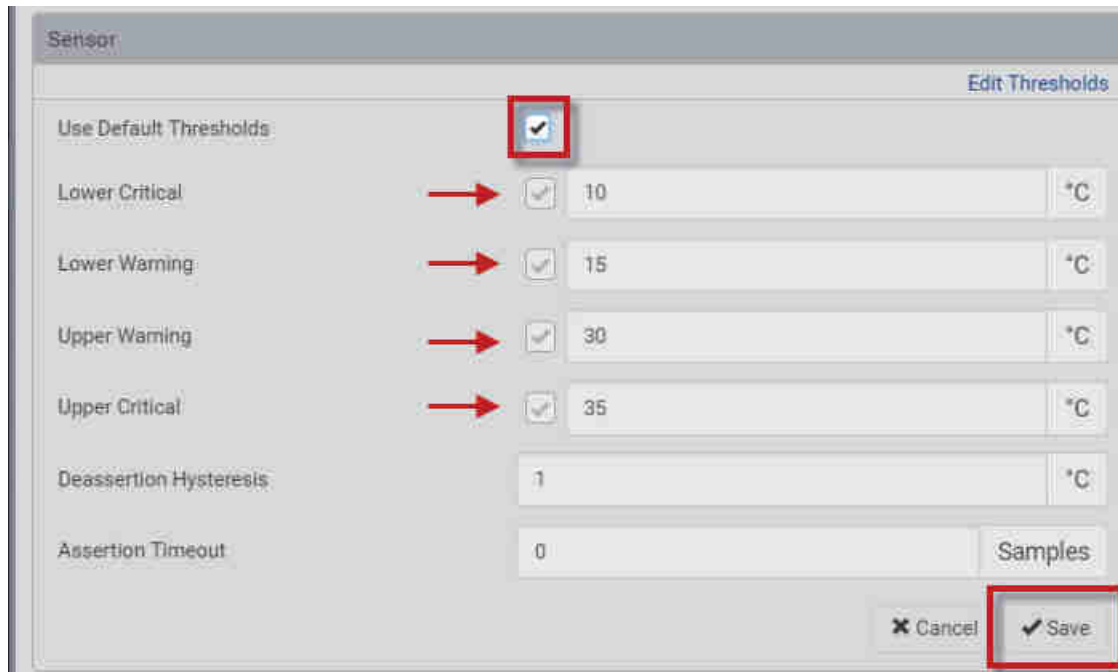

Additional Information

Legrand PDU Support page: <https://www.raritan.com/support/product/lg>

Legrand PDU Online Help: <http://help.raritan.com/lg>

For more details on sensors, download the Environmental Sensors and Actuators Guide from the Support page: <https://www.raritan.com/support/product/lg/>

⚠️ Consignes de sécurité (FR) (LU) (BE) (CH)

Avant toute intervention, couper le courant.
Respecter strictement les conditions d'installation et d'utilisation.

⚠️ Veiligheidsvoorschriften (NL) (BE)

Onderbreek voor enige ingreep de stroom.
Neem de installatie- en gebruiksvoorwaarden nauwgezet in acht.

⚠️ Safety instructions (GB) (IE)

Make sure the power supply is disconnected before any intervention.
Strictly comply with instructions for installation and use.

⚠️ Sicherheitshinweise (DE) (CH)

Vor jeglichem Eingriff die Spannungsfreiheit sicherstellen.
Einbau- und Gebrauchsanleitungen sind genau zu beachten.

⚠️ Consignas de seguridad (ES)

Antes de realizar cualquier intervención, cortar la corriente eléctrica.
Respetar estrictamente las condiciones de instalación y uso.

⚠️ Instruções de segurança (PT)

Antes de qualquer intervenção, desligar a corrente.
Respeitar rigorosamente as condições de instalação e de utilização.

⚠️ Συστάσεις ασφαλείας (GR) (CY)

Πριν από οποιαδήποτε επέμβαση, διακόψτε την παροχή ρεύματος.
Να τηρείτε αναστρά τας συνθήκες εγκατάστασης και χρήσης.

⚠️ Меры предосторожности (RU)

Отключить питание перед проведением любых ремонтных работ.
Строго соблюдайте требования к условиям монтажа и эксплуатации

⚠️ Güvenlik talimatları (TR) (CY)

Herhangi bir müdahaleden önce, akımı kesiniz.
Yerleştirme ve kullanım koşullarına titizlikle riayet ediniz.

⚠️ 安全提示

在任何干涉以前一定要断电，严格遵守安全
和使用的規定。

إرشادات الأمان: ⚠️

«اقطع التيار الكهربائي قبل أي تدخل. تفيداً تفيداً
تماماً بشروط التركيب والاستخدام.»