

Datový list | Objednáací číslo: 769-214

Základní svorka – 1 vodič / 1 pin; S trojitým příčným můstkovým propojením;

Na DIN lištu 35 × 15 a 35 × 7,5; 4 mm²; CAGE CLAMP®; 4,00 mm²; Šedá



www.wago.com/769-214

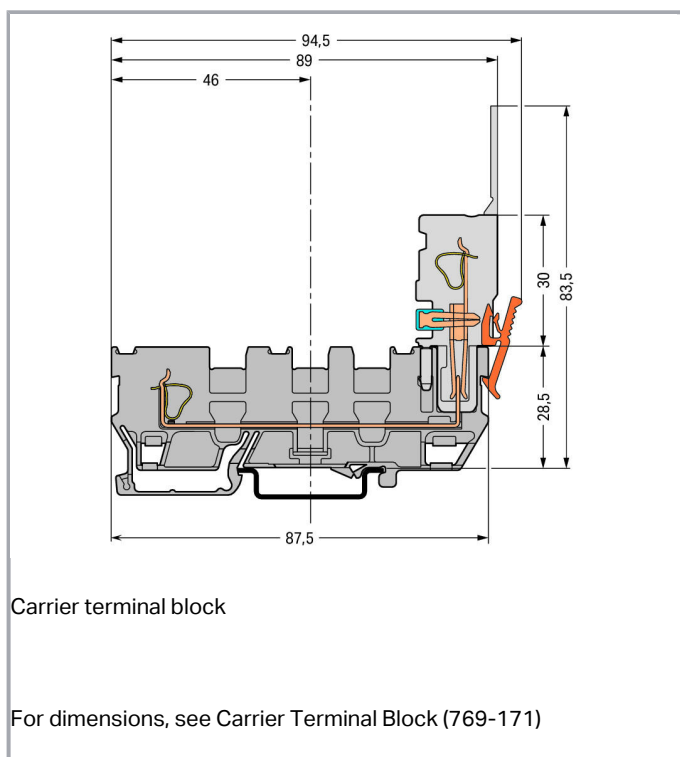
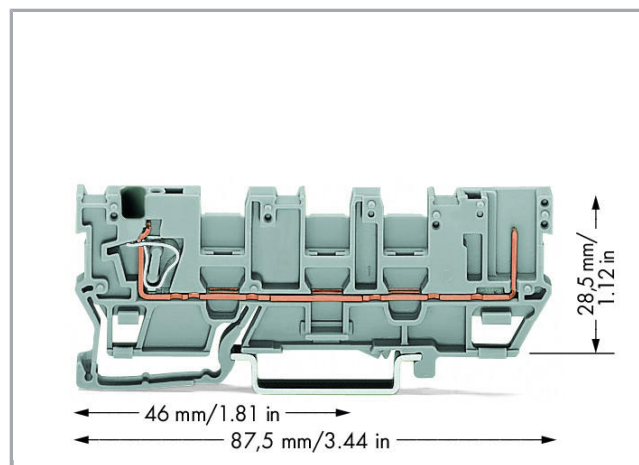
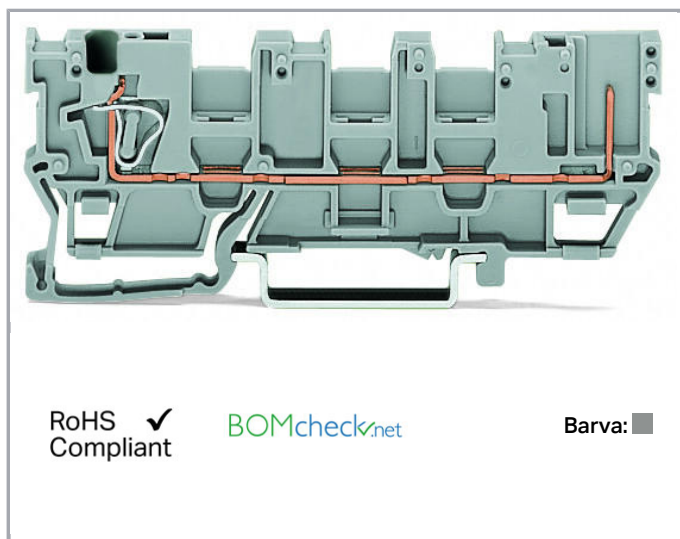

Data

Elektrické parametry



Ratings per IEC/EN 60664-1

Návrhové napětí (III / 3)	500 V
Návrhové rázové napětí (III / 3)	6 kV
Jmenovitý proud	32 A
Legenda (návrhové hodnoty)	(III / 3) \triangleq kategorie přepětí III / stupeň znečištění 3

Údaje o připojení

Připojovací technika	CAGE CLAMP®
Způsob ovládání	Ovládací nástroj
Materiály připojitelných vodičů	Měď
Jmenovitý průřez	4 mm ²
Plný vodič	0,08 ... 4 mm ² / 28 ... 12 AWG
Jemně laněný vodič	0,08 ... 4 mm ² / 28 ... 12 AWG
Délka odizolování	8 ... 9 mm / 0.31 ... 0.35 palec
Celkový počet kontaktních míst	1
Celkový počet potenciálů	1
Počet úrovní	1
Způsob zapojení	čelní připojení

Geometrické údaje

Šířka	5 mm / 0.197 inch
Výška od horní hrany lišty DIN 35	28,5 mm / 1.122 inch
Hloubka	87,5 mm / 3.445 inch

Mechanické parametry

Provedení	Horizontální provedení
Způsob montáže	Lišta DIN 35
Úroveň popisování	Středový popis

Údaje o materiálu

barva	Šedá
Izolační materiál	Polyamid 66 (PA 66)
Požární zatížení	0.169 MJ
Hmotnost	8.139 g



Obchodní údaje

Product Group	18 (X-COM-System)
Druh balení	BOX



Country of origin	DE
GTIN	4044918477130
Customs Tariff No.	85366990990

Atesty/certifikáty

Specifické atesty jednotlivých států

Logo	Schválení	Doplňkový text schválení	Název certifikátu
	CCA DEKRA Certification B.V.	EN 60947	NTR NL-7626
	CSA DEKRA Certification B.V.	C22.2 No. 158	1101144
	KEMA/KEUR DEKRA Certification B.V.	EN 60947	2190419.01

Atesty pro použití v lodním průmyslu

Logo	Schválení	Doplňkový text schválení	Název certifikátu
	ABS American Bureau of Shipping	EN 60947	14-HG1293677-PDA
	DNV GL Det Norske Veritas, Germanischer Lloyd	-	TAE00001V2
	LR Lloyds Register	EN 60947	91/20112 (E9)







Atesty UL

















Logo	Schválení	Doplňkový text schválení	Název certifikátu
	UR Underwriters Laboratories Inc.	UL 1977	E45171-20010720
	UR Underwriters Laboratories Inc.	UL 1059	20190731-E45172



Kompatibilní produkty

















Carrier rail















	Obj. č.: 210-112 Ocelová nosná lišta; 35 × 7,5 mm; Tloušťka 1 mm; Délka 2 m; Děrovaná; Dle normy EN 60715; Šířka otvorů 25 mm; vzdálenost mezi otvory 36 mm	www.wago.com/210-112
	Obj. č.: 210-113 Ocelová nosná lišta; 35 × 7,5 mm; Tloušťka 1 mm; Délka 2 m; Neděrovaná; Dle normy EN 60715	www.wago.com/210-113
	Obj. č.: 210-114 Ocelová nosná lišta; 35 × 15 mm; Tloušťka 1,5 mm; Délka 2 m; Neděrovaná; Podobné EN 60715	www.wago.com/210-114
	Obj. č.: 210-115 Ocelová nosná lišta; 35 × 7,5 mm; Tloušťka 1 mm; Délka 2 m; Děrovaná; Dle normy EN 60715; Šířka otvorů 18 mm; vzdálenost mezi otvory 25 mm	www.wago.com/210-115
	Obj. č.: 210-118 Ocelová nosná lišta; 35 × 15 mm; Tloušťka 2,3 mm; Délka 2 m; Neděrovaná; Dle normy EN 60715	www.wago.com/210-118
	Obj. č.: 210-196 Hliníková nosná lišta; 35 × 8,2 mm; Tloušťka 1,6 mm; Délka 2 m; Neděrovaná; Podobné EN 60715; Stříbrná	www.wago.com/210-196
	Obj. č.: 210-197 Ocelová nosná lišta; 35 × 15 mm; Tloušťka 1,5 mm; Délka 2 m; Děrovaná; Podobné EN 60715	www.wago.com/210-197
	Obj. č.: 210-198 Měděná nosná lišta; 35 × 15 mm; Tloušťka 2,3 mm; Délka 2 m; Neděrovaná; Dle normy EN 60715; Měděná	www.wago.com/210-198
	Obj. č.: 210-504 Ocelová nosná lišta; 35 × 7,5 mm; Tloušťka 1 mm; Délka 2 m; Děrovaná; Pásově zinkováno; Dle normy EN 60715	www.wago.com/210-504
	Obj. č.: 210-505 Ocelová nosná lišta; 35 × 7,5 mm; Tloušťka 1 mm; Délka 2 m; Neděrovaná; Pásově zinkováno; Dle normy EN 60715	www.wago.com/210-505
	Obj. č.: 210-506 Ocelová nosná lišta; 35 × 15 mm; Tloušťka 1,5 mm; Délka 2 m; Neděrovaná; Pásově zinkováno;	www.wago.com/210-506

















	Podobné EN 60715	
	Obj. č.: 210-508 Ocelová nosná lišta; 35 × 15 mm; Tloušťka 1,5 mm; Délka 2 m; Děrovaná; Pásově zinkováno; Podobné EN 60715	www.wago.com/210-508
End plate		
	Obj. č.: 769-315 Koncová bočnice a separátor; Tloušťka 1,1 mm; Šedá	www.wago.com/769-315
	Obj. č.: 769-316 Koncová bočnice a separátor; Tloušťka 1,1 mm; Oranžová	www.wago.com/769-316
Jumper		
	Obj. č.: 249-123 Vodičový můstek; Izolováno; L = 180 mm; Průřez vedení 0,75 mm ²	www.wago.com/249-123
	Obj. č.: 249-125 Vodičový můstek; Izolováno; L = 60 mm; Průřez vedení 0,75 mm ²	www.wago.com/249-125
	Obj. č.: 249-126 Vodičový můstek; Izolováno; L = 110 mm; Průřez vedení 0,75 mm ²	www.wago.com/249-126
	Obj. č.: 249-127 Vodičový můstek; Izolováno; L = 250 mm; Průřez vedení 0,75 mm ²	www.wago.com/249-127
	Obj. č.: 280-402 Příčný můstek; Izolováno; IN = IN svorky; Šedá	www.wago.com/280-402
	Obj. č.: 280-409 Příčný můstek ob svorku; Izolováno; IN = IN svorky; Šedá	www.wago.com/280-409
	Obj. č.: 780-452 Stupňovitý můstek; Izolováno; Z 1 na 2; Rozteč 5 mm; Vhodný pro 2vodičové pružinové svorkovnice; Šedá	www.wago.com/780-452
	Obj. č.: 780-453 Stupňovitý můstek; Izolováno; z 1 na 3; Rozteč 5 mm; Vhodný pro 2vodičové pružinové svorkovnice; Šedá	www.wago.com/780-453
	Obj. č.: 780-454 Stupňovitý můstek; Izolováno; Z 1 na 4; Rozteč 5 mm; Vhodný pro 2vodičové pružinové svorkovnice; Šedá	www.wago.com/780-454
	Obj. č.: 780-455 Stupňovitý můstek; Izolováno; Z 1 na 5; Rozteč 5 mm; Vhodný pro 2vodičové pružinové svorkovnice; Šedá	www.wago.com/780-455
	Obj. č.: 780-456 Stupňovitý můstek; Izolováno; Z 1 na 6; Rozteč 5 mm; Vhodný pro 2vodičové pružinové svorkovnice; Šedá	www.wago.com/780-456
	Obj. č.: 780-457 Stupňovitý můstek; Izolováno; Z 1 na 7; Rozteč 5 mm; Vhodný pro 2vodičové pružinové svorkovnice; Šedá	www.wago.com/780-457
	Obj. č.: 780-458 Stupňovitý můstek; Izolováno; Z 1 na 8; Rozteč 5 mm; Vhodný pro 2vodičové pružinové svorkovnice; Šedá	www.wago.com/780-458

check















Obj. č.: 210-136

	Zkušební hrot; Ø 2 mm; S 500mm vedením; Červená	www.wago.com/210-136
	Obj. č.: 210-137 Zkušební hrot; Ø 2,3 mm; S 500mm vedením; Žlutá	www.wago.com/210-137
tools		
	Obj. č.: 210-720 Ovládací nástroj; Břit: 3,5 × 0,5 mm; S částečně izolovanou rukojetí	www.wago.com/210-720
General accessories		
	Obj. č.: 280-404 Zkušební adaptér; Šířka 5 mm; Pro zkušební hrot 210-137 (Ø 2,3 mm); Vhodná pro svorky 1,5–4 mm ² ; Šedá	www.wago.com/280-404
	Obj. č.: 280-418 Modul pro zkušební zástrčku; Možnost řadového připojení; Vhodný ke všem řadovým svorkám WAGO řad 280 a 780 s drážkou pro můstek v napájecí liště; Šedá	www.wago.com/280-418
	Obj. č.: 280-419 Slepý modul; Možnost řadového připojení; K přeskočení svorek; Šedá	www.wago.com/280-419
	Obj. č.: 769-438 Kryt kolíků; S držákem značení pro Mini-WSB; Šedá	www.wago.com/769-438
	Obj. č.: 769-439 Kryt kolíků; S držákem značení pro Mini-WSB; Oranžová	www.wago.com/769-439
	Obj. č.: 769-501 1vodičový počáteční modul s pružinovou svorkovnicí; S integrovanou koncovou bočnicí; 4 mm ² ; 1pól.; 4,00 mm ² ; Šedá	www.wago.com/769-501
	Obj. č.: 769-501/000-006 1vodičový počáteční modul s pružinovou svorkovnicí; 4 mm ² ; 1pól.; 4,00 mm ² ; Modrá	www.wago.com/769-501/000-006
	Obj. č.: 769-501/000-016 1vodičový počáteční modul s pružinovou svorkovnicí; S integrovanou koncovou bočnicí; 4 mm ² ; 1pól.; 4,00 mm ² ; Zeleno-žlutá	www.wago.com/769-501/000-016
	Obj. č.: 769-502 1vodičový středový modul s pružinovou svorkovnicí; 4 mm ² ; 1pól.; 4,00 mm ² ; Šedá	www.wago.com/769-502
	Obj. č.: 769-502/000-006 1vodičový středový modul s pružinovou svorkovnicí; 4 mm ² ; 1pól.; 4,00 mm ² ; Modrá	www.wago.com/769-502/000-006
	Obj. č.: 769-502/000-016 1vodičový středový modul s pružinovou svorkovnicí; 4 mm ² ; 1pól.; 4,00 mm ² ; Zeleno-žlutá	www.wago.com/769-502/000-016
	Obj. č.: 769-503 1vodičový koncový modul s pružinovou svorkovnicí; 4 mm ² ; 1pól.; 4,00 mm ² ; Šedá	www.wago.com/769-503
	Obj. č.: 769-503/000-006 1vodičový koncový modul s pružinovou svorkovnicí; 4 mm ² ; 1pól.; 4,00 mm ² ; Modrá	www.wago.com/769-503/000-006
	Obj. č.: 769-503/000-016 1vodičový koncový modul s pružinovou svorkovnicí; 4 mm ² ; 1pól.; 4,00 mm ² ; Zeleno-žlutá	www.wago.com/769-503/000-016

	Obj. č.: 769-504 2vodičový počáteční modul s pružinovou svorkovnicí; S integrovanou koncovou bočnicí; 4 mm ² ; 1pól.; 4,00 mm ² ; Šedá	www.wago.com/769-504
	Obj. č.: 769-504/000-006 2vodičový počáteční modul s pružinovou svorkovnicí; S integrovanou koncovou bočnicí; 4 mm ² ; 1pól.; 4,00 mm ² ; Modrá	www.wago.com/769-504/000-006
	Obj. č.: 769-504/000-016 2vodičový počáteční modul s pružinovou svorkovnicí; 4 mm ² ; 1pól.; 4,00 mm ² ; Zeleno-žlutá	www.wago.com/769-504/000-016
	Obj. č.: 769-505 2vodičový středový modul s pružinovou svorkovnicí; 4 mm ² ; 1pól.; 4,00 mm ² ; Šedá	www.wago.com/769-505
	Obj. č.: 769-505/000-006 2vodičový středový modul s pružinovou svorkovnicí; 4 mm ² ; 1pól.; 4,00 mm ² ; Modrá	www.wago.com/769-505/000-006
	Obj. č.: 769-505/000-016 2vodičový středový modul s pružinovou svorkovnicí; 4 mm ² ; 1pól.; 4,00 mm ² ; Zeleno-žlutá	www.wago.com/769-505/000-016
	Obj. č.: 769-506 2vodičový koncový modul s pružinovou svorkovnicí; 4 mm ² ; 1pól.; 4,00 mm ² ; Šedá	www.wago.com/769-506
	Obj. č.: 769-506/000-006 2vodičový koncový modul s pružinovou svorkovnicí; 4 mm ² ; 1pól.; 4,00 mm ² ; Modrá	www.wago.com/769-506/000-006
	Obj. č.: 769-506/000-016 2vodičový koncový modul s pružinovou svorkovnicí; 4 mm ² ; 1pól.; 4,00 mm ² ; Zeleno-žlutá	www.wago.com/769-506/000-016
	Obj. č.: 769-512 1vodičový počáteční modul s pružinovou svorkovnicí; Úhlové provedení; 4 mm ² ; 1pól.; 4,00 mm ² ; Šedá	www.wago.com/769-512
	Obj. č.: 769-512/000-006 1vodičový počáteční modul s pružinovou svorkovnicí; Úhlové provedení; 4 mm ² ; 1pól.; 4,00 mm ² ; Modrá	www.wago.com/769-512/000-006
	Obj. č.: 769-512/000-016 1vodičový počáteční modul s pružinovou svorkovnicí; Úhlové provedení; 4 mm ² ; 1pól.; 4,00 mm ² ; Zeleno-žlutá	www.wago.com/769-512/000-016
	Obj. č.: 769-513 1vodičový středový modul s pružinovou svorkovnicí; Úhlové provedení; 4 mm ² ; 1pól.; 4,00 mm ² ; Šedá	www.wago.com/769-513
	Obj. č.: 769-513/000-006 1vodičový středový modul s pružinovou svorkovnicí; Úhlové provedení; 4 mm ² ; 1pól.; 4,00 mm ² ; Modrá	www.wago.com/769-513/000-006
	Obj. č.: 769-513/000-016 1vodičový středový modul s pružinovou svorkovnicí; Úhlové provedení; 4 mm ² ; 1pól.; 4,00 mm ² ; Zeleno-žlutá	www.wago.com/769-513/000-016
	Obj. č.: 769-515	

	1 vodičový koncový modul s pružinovou svorkovnicí; Úhlové provedení; 4 mm ² ; 1pól.; 4,00 mm ² ; Šedá	www.wago.com/769-515
	Obj. č.: 769-515/000-006 1 vodičový koncový modul s pružinovou svorkovnicí; Úhlové provedení; 4 mm ² ; 1pól.; 4,00 mm ² ; Modrá	www.wago.com/769-515/000-006
	Obj. č.: 769-515/000-016 1 vodičový koncový modul s pružinovou svorkovnicí; Úhlové provedení; 4 mm ² ; 1pól.; 4,00 mm ² ; Zeleno-žlutá	www.wago.com/769-515/000-016
Protective Warning Marker		
	Obj. č.: 280-415 Výstražný kryt; S černým symbolem blesku; Pro 5 svorek; Žlutá	www.wago.com/280-415
Coding		
	Obj. č.: 769-435 Kódovací kolík; Ke kódování pružinových svorkovnic; Pro základní svorky / konektory s pájecími piny; Oranžová	www.wago.com/769-435
assembling		
	Obj. č.: 209-106 Držák; K izolované montáži nosných lišt DIN 35; Šedá	www.wago.com/209-106
ferrule		
	Obj. č.: 216-101 Dutinka; Objímka na 0,5 mm ² / AWG 22; Bez plastového límce; Galvanicky pocínováno	www.wago.com/216-101
	Obj. č.: 216-102 Dutinka; Objímka na 0,75 mm ² / AWG 20; Bez plastového límce; Galvanicky pocínováno	www.wago.com/216-102
	Obj. č.: 216-103 Dutinka; Objímka na 1 mm ² / AWG 18; Bez plastového límce; Galvanicky pocínováno	www.wago.com/216-103
	Obj. č.: 216-104 Dutinka; Objímka na 1,5 mm ² / AWG 16; Bez plastového límce; Galvanicky pocínováno	www.wago.com/216-104
	Obj. č.: 216-201 Ferrule; Sleeve for 0.5 mm ² / 20 AWG; insulated; electro-tin plated; white	www.wago.com/216-201
	Obj. č.: 216-202 Ferrule; Sleeve for 0.75 mm ² / 18 AWG; insulated; electro-tin plated; gray	www.wago.com/216-202
	Obj. č.: 216-203 Dutinka; Objímka na 1 mm ² / AWG 18; S plastovým límcem; Galvanicky pocínováno; Červená	www.wago.com/216-203
	Obj. č.: 216-204 Dutinka; Objímka na 1,5 mm ² / AWG 16; S plastovým límcem; Galvanicky pocínováno; Černá	www.wago.com/216-204
	Obj. č.: 216-206 Dutinka; Objímka na 2,5 mm ² / AWG 14; S plastovým límcem; Galvanicky pocínováno; Modrá	www.wago.com/216-206
	Obj. č.: 216-301 Dutinka; Objímka na 0,25 mm ² / AWG 24; S plastovým límcem; Galvanicky pocínováno; Žlutá	www.wago.com/216-301
	Obj. č.: 216-302 Ferrule; Sleeve for 0.34 mm ² / 22 AWG; insulated; electro-tin plated; green	www.wago.com/216-302

Marking accessories

	Obj. č.: 2009-145 Mini-WSB Inline; Pro Smart Printer; Na cívce; Flexibilní, 5–5,2 mm; Bez potisku; Možnost naklapnutí; Bílá	www.wago.com/2009-145
	Obj. č.: 2009-145/000-002 Mini-WSB Inline; Pro Smart Printer; Na cívce; Flexibilní, 5–5,2 mm; Bez potisku; Možnost naklapnutí; Žlutá	www.wago.com/2009-145/000-002
	Obj. č.: 2009-145/000-005 Mini-WSB Inline; Pro Smart Printer; Na cívce; Flexibilní, 5–5,2 mm; Bez potisku; Možnost naklapnutí; Červená	www.wago.com/2009-145/000-005
	Obj. č.: 2009-145/000-006 Mini-WSB Inline; Pro Smart Printer; Na cívce; Flexibilní, 5–5,2 mm; Bez potisku; Možnost naklapnutí; Modrá	www.wago.com/2009-145/000-006
	Obj. č.: 2009-145/000-007 Mini-WSB Inline; Pro Smart Printer; Na cívce; Flexibilní, 5–5,2 mm; Bez potisku; Možnost naklapnutí; Šedá	www.wago.com/2009-145/000-007
	Obj. č.: 2009-145/000-012 Mini-WSB Inline; Pro Smart Printer; Na cívce; Flexibilní, 5–5,2 mm; Bez potisku; Možnost naklapnutí; Oranžová	www.wago.com/2009-145/000-012
	Obj. č.: 2009-145/000-023 Mini-WSB Inline; Pro Smart Printer; Na cívce; Flexibilní, 5–5,2 mm; Bez potisku; Možnost naklapnutí; Zelená	www.wago.com/2009-145/000-023
	Obj. č.: 2009-145/000-024 Mini-WSB Inline; Pro Smart Printer; Na cívce; Flexibilní, 5–5,2 mm; Bez potisku; Možnost naklapnutí; Fialová	www.wago.com/2009-145/000-024
	Obj. č.: 248-501 Systém rychlého popisování Mini-WSB; Bez potisku; Šířka štítků 5 mm; 10 řad po 10 štítcích na každé kartě	www.wago.com/248-501
	Obj. č.: 248-501/000-002 Popisovací karta Mini-WSB; Jako karta; Neflexibilní; Bez potisku; Možnost naklapnutí; Žlutá	www.wago.com/248-501/000-002
	Obj. č.: 248-501/000-005 Popisovací karta Mini-WSB; Jako karta; Neflexibilní; Bez potisku; Možnost naklapnutí; Červená	www.wago.com/248-501/000-005
	Obj. č.: 248-501/000-006 Popisovací karta Mini-WSB; Jako karta; Neflexibilní; Bez potisku; Možnost naklapnutí; Modrá	www.wago.com/248-501/000-006
	Obj. č.: 248-501/000-007 Popisovací karta Mini-WSB; Jako karta; Neflexibilní; Bez potisku; Možnost naklapnutí; Šedá	www.wago.com/248-501/000-007
	Obj. č.: 248-501/000-012 Popisovací karta Mini-WSB; Jako karta; Neflexibilní; Bez potisku; Možnost naklapnutí; Oranžová	www.wago.com/248-501/000-012
	Obj. č.: 248-501/000-017 Popisovací karta Mini-WSB; Jako karta; Neflexibilní; Bez potisku; Možnost naklapnutí; Světle zelená	www.wago.com/248-501/000-017



Obj. č.: 248-501/000-023
Popisovací karta Mini-WSB; Jako karta; Neflexibilní; Bez potisku; Možnost naklapnutí; Zelená

www.wago.com/248-501/000-023



Obj. č.: 248-501/000-024
Popisovací karta Mini-WSB; Jako karta; Neflexibilní; Bez potisku; Možnost naklapnutí; Fialová

www.wago.com/248-501/000-024

Female plug



Obj. č.: 769-101
1 vodičová pružinová svorkovnice; 4 mm²; 1pól.; 4,00 mm²; Šedá

www.wago.com/769-101



Obj. č.: 769-101/000-006
1 vodičová pružinová svorkovnice; 4 mm²; 1pól.; 4,00 mm²; Modrá

www.wago.com/769-101/000-006



Obj. č.: 769-101/000-016
1 vodičová pružinová svorkovnice; 4 mm²; 1pól.; 4,00 mm²; Zeleno-žlutá

www.wago.com/769-101/000-016



Obj. č.: 769-101/022-000
1 vodičová pružinová svorkovnice; Úhlové provedení; 4 mm²; 1pól.; 4,00 mm²; Šedá

www.wago.com/769-101/022-000



Obj. č.: 769-101/022-016
1 vodičová pružinová svorkovnice; Úhlové provedení; 4 mm²; 1pól.; 4,00 mm²; Zeleno-žlutá

www.wago.com/769-101/022-016



Obj. č.: 769-102
1 vodičová pružinová svorkovnice; 4 mm²; 2pól.; 4,00 mm²; Šedá

www.wago.com/769-102



Obj. č.: 769-102/000-006
1 vodičová pružinová svorkovnice; 4 mm²; 2pól.; 4,00 mm²; Modrá

www.wago.com/769-102/000-006



Obj. č.: 769-102/000-036
1 vodičová pružinová svorkovnice; 4 mm²; 2pól.; 4,00 mm²; Šedá / zelená – žlutá

www.wago.com/769-102/000-036



Obj. č.: 769-102/000-037
1 vodičová pružinová svorkovnice; 4 mm²; 2pól.; 4,00 mm²; Zelená – žlutá / šedá

www.wago.com/769-102/000-037



Obj. č.: 769-102/022-000
1 vodičová pružinová svorkovnice; Úhlové provedení; 4 mm²; 2pól.; 4,00 mm²; Šedá

www.wago.com/769-102/022-000



Obj. č.: 769-103
1 vodičová pružinová svorkovnice; 4 mm²; 3pól.; 4,00 mm²; Šedá

www.wago.com/769-103

















Obj. č.: 769-103/000-006
1 vodičová pružinová svorkovnice; 4 mm²; 3pól.; 4,00 mm²; Modrá

www.wago.com/769-103/000-006



Obj. č.: 769-103/000-036
1 vodičová pružinová svorkovnice; 4 mm²; 3pól.; 4,00 mm²; Šedá / zelená – žlutá

www.wago.com/769-103/000-036

	<p>Obj. č.: 769-103/000-037 1 vodičová pružinová svorkovnice; 4 mm²; 3pól.; 4,00 mm²; Zelená – žlutá / šedá</p>	<p>www.wago.com/769-103/000-037</p>
	<p>Obj. č.: 769-103/000-038 1 vodičová pružinová svorkovnice; 4 mm²; 3pól.; 4,00 mm²; Šedá / modrá / zelená – žlutá</p>	<p>www.wago.com/769-103/000-038</p>
	<p>Obj. č.: 769-103/000-039 1 vodičová pružinová svorkovnice; 4 mm²; 3pól.; 4,00 mm²; Zelená – žlutá, modrá, šedá</p>	<p>www.wago.com/769-103/000-039</p>
	<p>Obj. č.: 769-103/022-000 1 vodičová pružinová svorkovnice; Úhlové provedení; 4 mm²; 3pól.; 4,00 mm²; Šedá</p>	<p>www.wago.com/769-103/022-000</p>
	<p>Obj. č.: 769-104 1 vodičová pružinová svorkovnice; 4 mm²; 4pól.; 4,00 mm²; Šedá</p>	<p>www.wago.com/769-104</p>
	<p>Obj. č.: 769-104/000-006 1 vodičová pružinová svorkovnice; 4 mm²; 4pól.; 4,00 mm²; Modrá</p>	<p>www.wago.com/769-104/000-006</p>
	<p>Obj. č.: 769-104/000-036 1 vodičová pružinová svorkovnice; 4 mm²; 4pól.; 4,00 mm²; Šedá / zelená – žlutá</p>	<p>www.wago.com/769-104/000-036</p>
	<p>Obj. č.: 769-104/000-037 1 vodičová pružinová svorkovnice; 4 mm²; 4pól.; 4,00 mm²; Zelená – žlutá / šedá</p>	<p>www.wago.com/769-104/000-037</p>
	<p>Obj. č.: 769-104/000-038 1 vodičová pružinová svorkovnice; 4 mm²; 4pól.; 4,00 mm²; Šedá / modrá / zelená – žlutá</p>	<p>www.wago.com/769-104/000-038</p>
	<p>Obj. č.: 769-104/000-039 1 vodičová pružinová svorkovnice; 4 mm²; 4pól.; 4,00 mm²; Zelená – žlutá, modrá, šedá</p>	<p>www.wago.com/769-104/000-039</p>
	<p>Obj. č.: 769-104/022-000 1 vodičová pružinová svorkovnice; Úhlové provedení; 4 mm²; 4pól.; 4,00 mm²; Šedá</p>	<p>www.wago.com/769-104/022-000</p>
	<p>Obj. č.: 769-105 1 vodičová pružinová svorkovnice; 4 mm²; 5pól.; 4,00 mm²; Šedá</p>	<p>www.wago.com/769-105</p>
	<p>Obj. č.: 769-105/000-006 1 vodičová pružinová svorkovnice; 4 mm²; 5pól.; 4,00 mm²; Modrá</p>	<p>www.wago.com/769-105/000-006</p>
	<p>Obj. č.: 769-105/000-036 1 vodičová pružinová svorkovnice; 4 mm²; 5pól.; 4,00 mm²; Šedá / zelená – žlutá</p>	<p>www.wago.com/769-105/000-036</p>
	<p>Obj. č.: 769-105/000-037 1 vodičová pružinová svorkovnice; 4 mm²; 5pól.; 4,00 mm²; Zelená – žlutá / šedá</p>	<p>www.wago.com/769-105/000-037</p>



Obj. č.: 769-105/000-038

1 vodičová pružinová svorkovnice; 4 mm²; 5pól.; 4,00 mm²; Šedá / modrá / zelená – žlutá

www.wago.com/769-105/000-038



Obj. č.: 769-105/000-039

1 vodičová pružinová svorkovnice; 4 mm²; 5pól.; 4,00 mm²; Zelená – žlutá, modrá, šedá

www.wago.com/769-105/000-039



Obj. č.: 769-105/022-000

1 vodičová pružinová svorkovnice; Úhlové provedení; 4 mm²; 5pól.; 4,00 mm²; Šedá

www.wago.com/769-105/022-000



Obj. č.: 769-106

1 vodičová pružinová svorkovnice; 4 mm²; 6pól.; 4,00 mm²; Šedá

www.wago.com/769-106



Obj. č.: 769-106/000-006

1 vodičová pružinová svorkovnice; 4 mm²; 6pól.; 4,00 mm²; Modrá

www.wago.com/769-106/000-006



Obj. č.: 769-106/000-036

1 vodičová pružinová svorkovnice; 4 mm²; 6pól.; 4,00 mm²; Šedá / zelená – žlutá

www.wago.com/769-106/000-036



Obj. č.: 769-106/000-037

1 vodičová pružinová svorkovnice; 4 mm²; 6pól.; 4,00 mm²; Zelená – žlutá / šedá

www.wago.com/769-106/000-037



Obj. č.: 769-106/000-038

1 vodičová pružinová svorkovnice; 4 mm²; 6pól.; 4,00 mm²; Šedá / modrá / zelená – žlutá

www.wago.com/769-106/000-038



Obj. č.: 769-106/000-039

1 vodičová pružinová svorkovnice; 4 mm²; 6pól.; 4,00 mm²; Zelená – žlutá, modrá, šedá

www.wago.com/769-106/000-039



Obj. č.: 769-106/022-000

1 vodičová pružinová svorkovnice; Úhlové provedení; 4 mm²; 6pól.; 4,00 mm²; Šedá

www.wago.com/769-106/022-000



Obj. č.: 769-107

1 vodičová pružinová svorkovnice; 4 mm²; 7pól.; 4,00 mm²; Šedá

www.wago.com/769-107



Obj. č.: 769-107/000-006

1 vodičová pružinová svorkovnice; 4 mm²; 7pól.; 4,00 mm²; Modrá

www.wago.com/769-107/000-006



Obj. č.: 769-107/000-036

1 vodičová pružinová svorkovnice; 4 mm²; 7pól.; 4,00 mm²; Šedá / zelená – žlutá

www.wago.com/769-107/000-036



Obj. č.: 769-107/000-037

1 vodičová pružinová svorkovnice; 4 mm²; 7pól.; 4,00 mm²; Zelená – žlutá / šedá















www.wago.com/769-107/000-037



Obj. č.: 769-107/000-038

1 vodičová pružinová svorkovnice; 4 mm²; 7pól.; 4,00 mm²; Šedá / modrá / zelená – žlutá

www.wago.com/769-107/000-038

	<p>Obj. č.: 769-107/000-039 1 vodičová pružinová svorkovnice; 4 mm²; 7pól.; 4,00 mm²; Zelená – žlutá, modrá, šedá</p>	<p>www.wago.com/769-107/000-039</p>
	<p>Obj. č.: 769-107/022-000 1 vodičová pružinová svorkovnice; Úhlové provedení; 4 mm²; 7pól.; 4,00 mm²; Šedá</p>	<p>www.wago.com/769-107/022-000</p>
	<p>Obj. č.: 769-108 1 vodičová pružinová svorkovnice; 4 mm²; 8pól.; 4,00 mm²; Šedá</p>	<p>www.wago.com/769-108</p>
	<p>Obj. č.: 769-108/000-006 1 vodičová pružinová svorkovnice; 4 mm²; 8pól.; 4,00 mm²; Modrá</p>	<p>www.wago.com/769-108/000-006</p>
	<p>Obj. č.: 769-108/000-036 1 vodičová pružinová svorkovnice; 4 mm²; 8pól.; 4,00 mm²; Šedá / zelená – žlutá</p>	<p>www.wago.com/769-108/000-036</p>
	<p>Obj. č.: 769-108/000-037 1 vodičová pružinová svorkovnice; 4 mm²; 8pól.; 4,00 mm²; Zelená – žlutá / šedá</p>	<p>www.wago.com/769-108/000-037</p>
	<p>Obj. č.: 769-108/000-038 1 vodičová pružinová svorkovnice; 4 mm²; 8pól.; 4,00 mm²; Šedá / modrá / zelená – žlutá</p>	<p>www.wago.com/769-108/000-038</p>
	<p>Obj. č.: 769-108/000-039 1 vodičová pružinová svorkovnice; 4 mm²; 8pól.; 4,00 mm²; Zelená – žlutá, modrá, šedá</p>	<p>www.wago.com/769-108/000-039</p>
	<p>Obj. č.: 769-108/022-000 1 vodičová pružinová svorkovnice; Úhlové provedení; 4 mm²; 8pól.; 4,00 mm²; Šedá</p>	<p>www.wago.com/769-108/022-000</p>
	<p>Obj. č.: 769-109 1 vodičová pružinová svorkovnice; 4 mm²; 9pól.; 4,00 mm²; Šedá</p>	<p>www.wago.com/769-109</p>
	<p>Obj. č.: 769-109/000-006 1 vodičová pružinová svorkovnice; 4 mm²; 9pól.; 4,00 mm²; Modrá</p>	<p>www.wago.com/769-109/000-006</p>
	<p>Obj. č.: 769-109/000-036 1 vodičová pružinová svorkovnice; 4 mm²; 9pól.; 4,00 mm²; Šedá / zelená – žlutá</p>	<p>www.wago.com/769-109/000-036</p>
	<p>Obj. č.: 769-109/000-037 1 vodičová pružinová svorkovnice; 4 mm²; 9pól.; 4,00 mm²; Zelená – žlutá / šedá</p>	<p>www.wago.com/769-109/000-037</p>
	<p>Obj. č.: 769-109/000-038 1 vodičová pružinová svorkovnice; 4 mm²; 9pól.; 4,00 mm²; Šedá / modrá / zelená – žlutá</p>	<p>www.wago.com/769-109/000-038</p>
	<p>Obj. č.: 769-109/000-039 1 vodičová pružinová svorkovnice; 4 mm²; 9pól.; 4,00 mm²; Zelená – žlutá, modrá, šedá</p>	<p>www.wago.com/769-109/000-039</p>



Obj. č.: 769-109/022-000
1 vodičová pružinová svorkovnice; Úhlové provedení; 4 mm²; 9pól.; 4,00 mm²; Šedá

www.wago.com/769-109/022-000



Obj. č.: 769-110
1 vodičová pružinová svorkovnice; 4 mm²; 10pól.; 4,00 mm²; Šedá

www.wago.com/769-110



Obj. č.: 769-110/000-006
1 vodičová pružinová svorkovnice; 4 mm²; 10pól.; 4,00 mm²; Modrá

www.wago.com/769-110/000-006



Obj. č.: 769-110/000-036
1 vodičová pružinová svorkovnice; 4 mm²; 10pól.; 4,00 mm²; Šedá / zelená – žlutá

www.wago.com/769-110/000-036



Obj. č.: 769-110/000-037
1 vodičová pružinová svorkovnice; 4 mm²; 10pól.; 4,00 mm²; Zelená – žlutá / šedá

www.wago.com/769-110/000-037



Obj. č.: 769-110/000-038
1 vodičová pružinová svorkovnice; 4 mm²; 10pól.; 4,00 mm²; Šedá / modrá / zelená – žlutá

www.wago.com/769-110/000-038



Obj. č.: 769-110/000-039
1 vodičová pružinová svorkovnice; 4 mm²; 10pól.; 4,00 mm²; Zelená – žlutá, modrá, šedá

www.wago.com/769-110/000-039



Obj. č.: 769-110/022-000
1 vodičová pružinová svorkovnice; Úhlové provedení; 4 mm²; 10pól.; 4,00 mm²; Šedá

www.wago.com/769-110/022-000



Obj. č.: 769-111
1 vodičová pružinová svorkovnice; 4 mm²; 11pól.; 4,00 mm²; Šedá

www.wago.com/769-111



Obj. č.: 769-111/000-006
1 vodičová pružinová svorkovnice; 4 mm²; 11pól.; 4,00 mm²; Modrá

www.wago.com/769-111/000-006



Obj. č.: 769-111/000-036
1 vodičová pružinová svorkovnice; 4 mm²; 11pól.; 4,00 mm²; Šedá / zelená – žlutá

www.wago.com/769-111/000-036



Obj. č.: 769-111/000-037
1 vodičová pružinová svorkovnice; 4 mm²; 11pól.; 4,00 mm²; Zelená – žlutá / šedá

www.wago.com/769-111/000-037



Obj. č.: 769-111/000-038
1 vodičová pružinová svorkovnice; 4 mm²; 11pól.; 4,00 mm²; Šedá / modrá / zelená – žlutá

www.wago.com/769-111/000-038

















Obj. č.: 769-111/000-039
1 vodičová pružinová svorkovnice; 4 mm²; 11pól.; 4,00 mm²; Zelená – žlutá, modrá, šedá

www.wago.com/769-111/000-039



Obj. č.: 769-111/022-000
1 vodičová pružinová svorkovnice; Úhlové provedení; 4 mm²; 11pól.; 4,00 mm²; Šedá

www.wago.com/769-111/022-000

	Obj. č.: 769-112 1vodičová pružinová svorkovnice; 4 mm ² ; 12pól.; 4,00 mm ² ; Šedá	www.wago.com/769-112
	Obj. č.: 769-112/000-006 1vodičová pružinová svorkovnice; 4 mm ² ; 12pól.; 4,00 mm ² ; Modrá	www.wago.com/769-112/000-006
	Obj. č.: 769-112/000-036 1vodičová pružinová svorkovnice; 4 mm ² ; 12pól.; 4,00 mm ² ; Šedá / zelená – žlutá	www.wago.com/769-112/000-036
	Obj. č.: 769-112/000-037 1vodičová pružinová svorkovnice; 4 mm ² ; 12pól.; 4,00 mm ² ; Zelená – žlutá / šedá	www.wago.com/769-112/000-037
	Obj. č.: 769-112/000-038 1vodičová pružinová svorkovnice; 4 mm ² ; 12pól.; 4,00 mm ² ; Šedá / modrá / zelená – žlutá	www.wago.com/769-112/000-038
	Obj. č.: 769-112/000-039 1vodičová pružinová svorkovnice; 4 mm ² ; 12pól.; 4,00 mm ² ; Zelená – žlutá, modrá, šedá	www.wago.com/769-112/000-039
	Obj. č.: 769-112/022-000 1vodičová pružinová svorkovnice; Úhlové provedení; 4 mm ² ; 12pól.; 4,00 mm ² ; Šedá	www.wago.com/769-112/022-000
	Obj. č.: 769-113 1vodičová pružinová svorkovnice; 4 mm ² ; 13pól.; 4,00 mm ² ; Šedá	www.wago.com/769-113
	Obj. č.: 769-113/000-036 1vodičová pružinová svorkovnice; 4 mm ² ; 13pól.; 4,00 mm ² ; Šedá / zelená – žlutá	www.wago.com/769-113/000-036
	Obj. č.: 769-113/000-037 1vodičová pružinová svorkovnice; 4 mm ² ; 13pól.; 4,00 mm ² ; Zelená – žlutá / šedá	www.wago.com/769-113/000-037
	Obj. č.: 769-113/000-038 1vodičová pružinová svorkovnice; 4 mm ² ; 13pól.; 4,00 mm ² ; Šedá / modrá / zelená – žlutá	www.wago.com/769-113/000-038
	Obj. č.: 769-113/000-039 1vodičová pružinová svorkovnice; 4 mm ² ; 13pól.; 4,00 mm ² ; Zelená – žlutá, modrá, šedá	www.wago.com/769-113/000-039
	Obj. č.: 769-113/022-000 1vodičová pružinová svorkovnice; Úhlové provedení; 4 mm ² ; 13pól.; 4,00 mm ² ; Šedá	www.wago.com/769-113/022-000
	Obj. č.: 769-114 1vodičová pružinová svorkovnice; 4 mm ² ; 14pól.; 4,00 mm ² ; Šedá	www.wago.com/769-114
	Obj. č.: 769-114/000-006 1vodičová pružinová svorkovnice; 4 mm ² ; 14pól.; 4,00 mm ² ; Modrá	www.wago.com/769-114/000-006



Obj. č.: 769-114/000-036

1 vodičová pružinová svorkovnice; 4 mm²; 14pól.; 4,00 mm²; Šedá / zelená – žlutá

www.wago.com/769-114/000-036



Obj. č.: 769-114/000-037

1 vodičová pružinová svorkovnice; 4 mm²; 14pól.; 4,00 mm²; Zelená – žlutá / šedá

www.wago.com/769-114/000-037



Obj. č.: 769-114/000-038

1 vodičová pružinová svorkovnice; 4 mm²; 14pól.; 4,00 mm²; Šedá / modrá / zelená – žlutá

www.wago.com/769-114/000-038



Obj. č.: 769-114/000-039

1 vodičová pružinová svorkovnice; 4 mm²; 14pól.; 4,00 mm²; Zelená – žlutá, modrá, šedá

www.wago.com/769-114/000-039



Obj. č.: 769-114/022-000

1 vodičová pružinová svorkovnice; Úhlové provedení; 4 mm²; 14pól.; 4,00 mm²; Šedá

www.wago.com/769-114/022-000



Obj. č.: 769-115

1 vodičová pružinová svorkovnice; 4 mm²; 15pól.; 4,00 mm²; Šedá

www.wago.com/769-115



Obj. č.: 769-115/000-036

1 vodičová pružinová svorkovnice; 4 mm²; 15pól.; 4,00 mm²; Šedá / zelená – žlutá

www.wago.com/769-115/000-036



Obj. č.: 769-115/000-037

1 vodičová pružinová svorkovnice; 4 mm²; 15pól.; 4,00 mm²; Zelená – žlutá / šedá

www.wago.com/769-115/000-037



Obj. č.: 769-115/000-038

1 vodičová pružinová svorkovnice; 4 mm²; 15pól.; 4,00 mm²; Šedá / modrá / zelená – žlutá

www.wago.com/769-115/000-038



Obj. č.: 769-115/000-039

1 vodičová pružinová svorkovnice; 4 mm²; 15pól.; 4,00 mm²; Zelená – žlutá, modrá, šedá

www.wago.com/769-115/000-039



Obj. č.: 769-115/022-000

1 vodičová pružinová svorkovnice; Úhlové provedení; 4 mm²; 15pól.; 4,00 mm²; Šedá

www.wago.com/769-115/022-000



Obj. č.: 769-121

2 vodičová pružinová svorkovnice; 4 mm²; 1pól.; 4,00 mm²; Šedá

www.wago.com/769-121



Obj. č.: 769-121/000-016

2 vodičová pružinová svorkovnice; 4 mm²; 1pól.; 4,00 mm²; Zeleno-žlutá

www.wago.com/769-121/000-016



Obj. č.: 769-122

2 vodičová pružinová svorkovnice; 4 mm²; 2pól.; 4,00 mm²; Šedá

www.wago.com/769-122



Obj. č.: 769-123

2 vodičová pružinová svorkovnice; 4 mm²; 3pól.; 4,00 mm²; Šedá















www.wago.com/769-123



Obj. č.: 769-124

2 vodičová pružinová svorkovnice; 4 mm²; 4pól.; 4,00 mm²; Šedá

www.wago.com/769-124

	Obj. č.: 769-125 2vodičová pružinová svorkovnice; 4 mm ² ; 5pól.; 4,00 mm ² ; Šedá	www.wago.com/769-125
	Obj. č.: 769-126 2vodičová pružinová svorkovnice; 4 mm ² ; 6pól.; 4,00 mm ² ; Šedá	www.wago.com/769-126
	Obj. č.: 769-127 2vodičová pružinová svorkovnice; 4 mm ² ; 7pól.; 4,00 mm ² ; Šedá	www.wago.com/769-127
	Obj. č.: 769-128 2vodičová pružinová svorkovnice; 4 mm ² ; 8pól.; 4,00 mm ² ; Šedá	www.wago.com/769-128
	Obj. č.: 769-129 2vodičová pružinová svorkovnice; 4 mm ² ; 9pól.; 4,00 mm ² ; Šedá	www.wago.com/769-129
	Obj. č.: 769-130 2vodičová pružinová svorkovnice; 4 mm ² ; 10pól.; 4,00 mm ² ; Šedá	www.wago.com/769-130
	Obj. č.: 769-131 2vodičová pružinová svorkovnice; 4 mm ² ; 11pól.; 4,00 mm ² ; Šedá	www.wago.com/769-131
	Obj. č.: 769-132 2vodičová pružinová svorkovnice; 4 mm ² ; 12pól.; 4,00 mm ² ; Šedá	www.wago.com/769-132
	Obj. č.: 769-133 2vodičová pružinová svorkovnice; 4 mm ² ; 13pól.; 4,00 mm ² ; Šedá	www.wago.com/769-133
	Obj. č.: 769-134 2vodičová pružinová svorkovnice; 4 mm ² ; 14pól.; 4,00 mm ² ; Šedá	www.wago.com/769-134
	Obj. č.: 769-135 2vodičová pružinová svorkovnice; 4 mm ² ; 15pól.; 4,00 mm ² ; Šedá	www.wago.com/769-135
Insulation stop		
	Obj. č.: 769-470 Izolační zarážka; 0,08–0,2 mm ² „e“ (0,14 mm ² „f“); 5 ks/pás; Bílá	www.wago.com/769-470
	Obj. č.: 769-471 Izolační zarážka; 0,25–0,5 mm ² ; 5 ks/pás; Světle šedá	www.wago.com/769-471
	Obj. č.: 769-472 Izolační zarážka; 0,75–1 mm ² ; 5 ks/pás; Tmavě šedá	www.wago.com/769-472

Ke stažení

Documentation

Additional Information

Technical explanations

03-Apr-2019

pdf
2,1 MB

Stáhnout

CAD/CAE-Data

CAD data

2D/3D Models 769-214

URL

Stáhnout

CAE data

EPLAN Data Portal 769-214

Stáhnout

WSCAD Universe 769-214

Stáhnout

Handling Instructions

Assembly

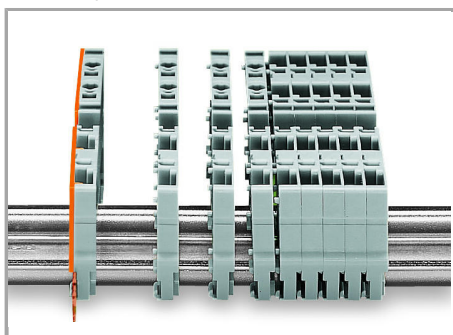

Snap individual carrier terminal blocks onto the carrier rail and slide together.

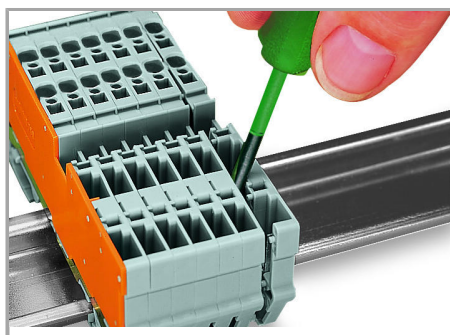

Open the assembly by laterally sliding a block via operating tool and remove terminal block via release lever.

Inserting a conductor

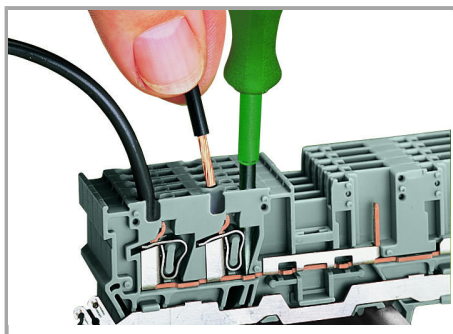

CAGE CLAMP® connection

Carrier terminal block: Insert/remove conductor via operating tool (3.5 x 0.5 mm blade).

Jumpered

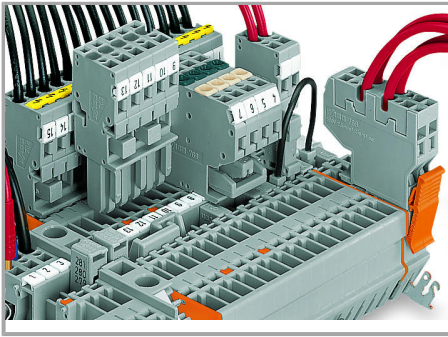

Commoning with adjacent or staggered jumpers –

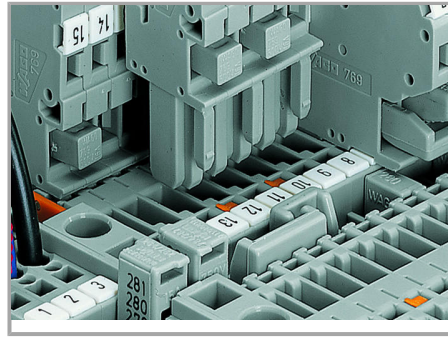

Commoning carrier terminal blocks via staggered jumpers.

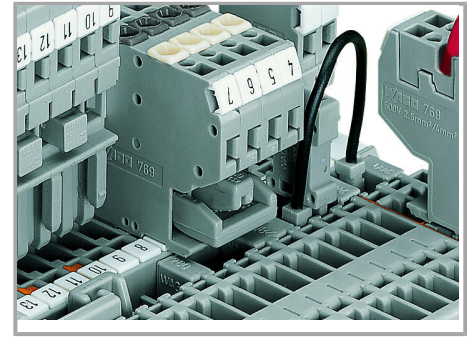

Commoning a 2-conductor female plug via staggered jumper and carrier terminal blocks via adjacent jumpers.

push jumpers down until fully inserted.

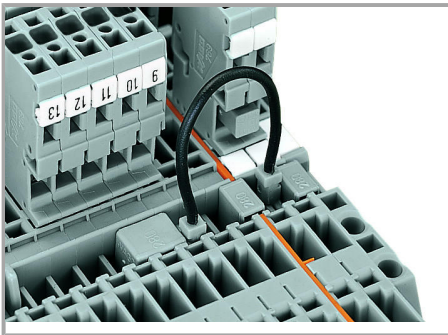

Commoning carrier terminal blocks via push-in type wire jumpers or adjacent jumpers – even over an intermediate plate.

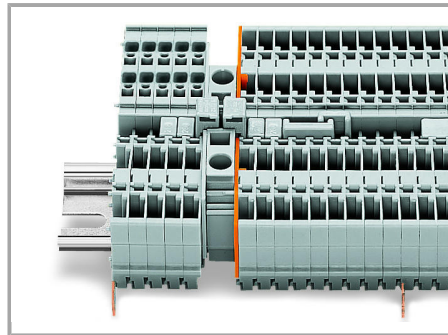

Commoning "supply terminal blocks" (up to 10 mm²/8 AWG) with carrier terminal blocks via step-down jumpers.

Testing

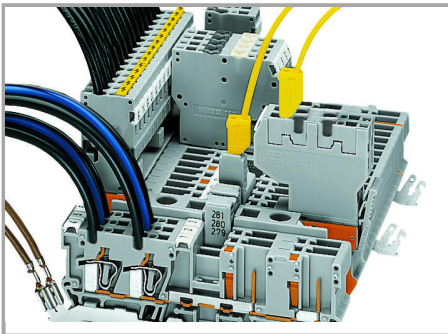

Testing via 2 or 2.3 mm Ø test plugs.

Coding

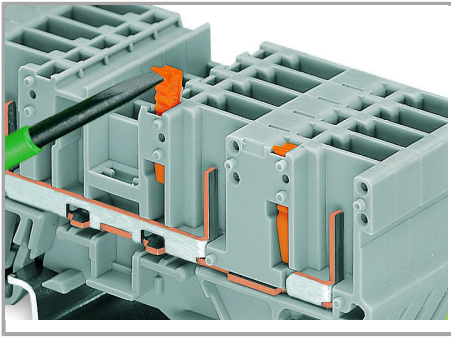

Snap coding pin in proper direction on carrier terminal block.

Shown: Coding pin removal from carrier terminal block.

Locking

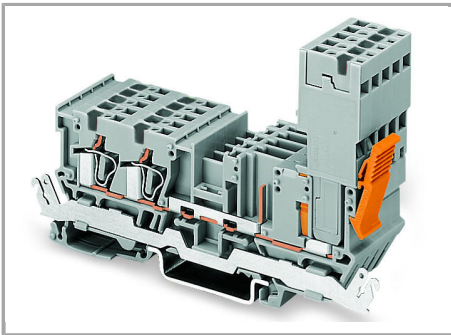

Female plug secured with locking lever on the terminal block side.

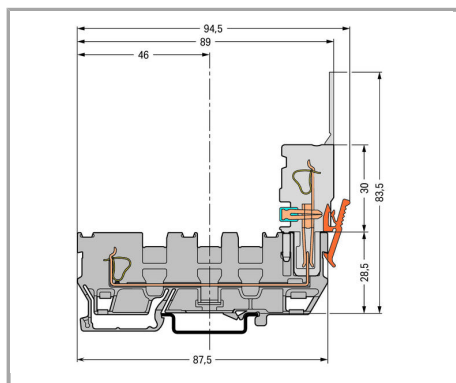

Carrier terminal block

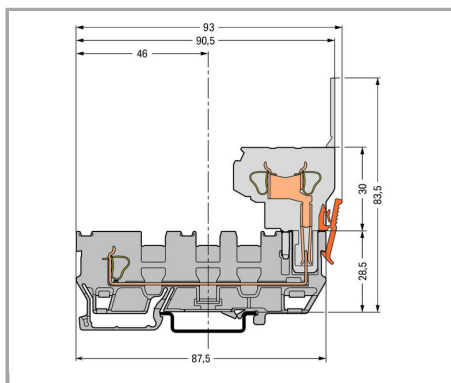

Carrier terminal block

For dimensions, see Carrier Terminal Block (769-171)

For dimensions, see Carrier Terminal Block (769-171)

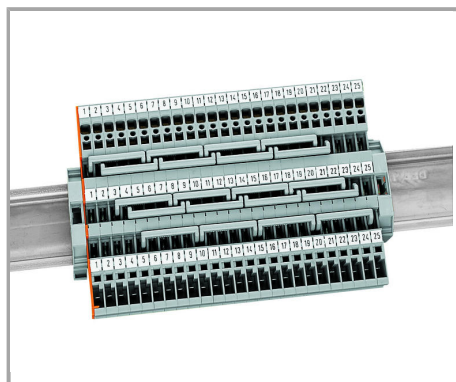

1-conductor/1-pin carrier terminal blocks with three jumper positions

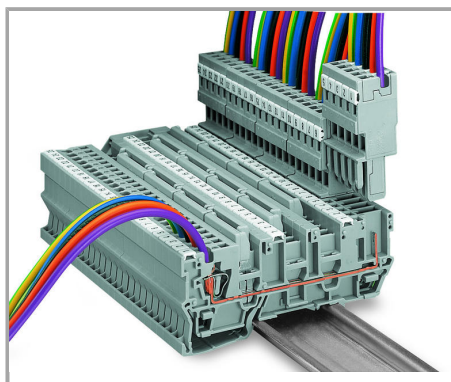

1-conductor/1-pin carrier terminal blocks with three jumper positions

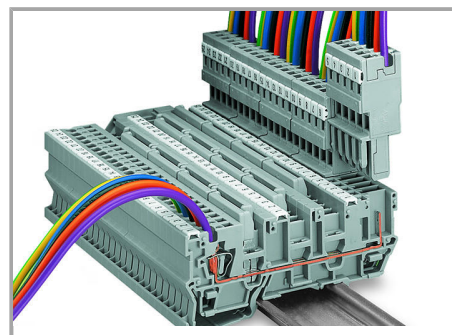

1-conductor/1-pin carrier terminal block with three jumper positions

1-connector female plug, straight*

The three jumper positions allow up to six commoning options for staggered jumpers.

The three jumper positions allow up to six commoning options for staggered jumpers.

*1-conductor angled female plug is also possible!

Produktová rodina

X-COM

[Zobrazit všechny produkty z rodiny](#)



Změny vyhrazeny.

WAGO Elektro spol. sr. o.
Rozvodova 1116/36
143 00 Praha 12 - Modřany
Tel.: +420 261 090 143
Email: info.cz@wago.com, wago-cz@wago.com

Máte otázky ohledně našich produktů?
Kdykoli nám zavolejte na číslo +420 261 090 143.