

22260332	DATA SHEET	
Valid from: 21.12.2023	AB-C4-M12MS-(L*)PUR-M12FA	

Product description

- Sensor/actuator cable, 4-pol, PUR halogen-free, black
- straight M12-plug on angled M12-jack



General characteristics

Number of pins	4
Ambient temperature	-25 °C to +90 °C (-13°F to 194°F) (plug / jack) -40 °C to +80 °C (-40°F to 176°F) (cable, fixed installation) -25 °C to +80 °C (-13°F to 176°F) (cable, movable installation)
Degree of protection	IP65 / IP67 / IP68
Coding	A-standard
Tightening torque	0,4 Nm (M12-connector)
Plugging cycles	≥ 100

Variation

Article number	Description	Length [m]	Configuration
22260332	AB-C4-M12MS-0,3PUR-M12FA	0,3	straight - angled
22260333	AB-C4-M12MS-0,6PUR-M12FA	0,6	straight - angled
22260334	AB-C4-M12MS-1,0PUR-M12FA	1	straight - angled
22260335	AB-C4-M12MS-2,0PUR-M12FA	2	straight - angled
22260968	AB-C4-M12MS-3,0PUR-M12FA	3	straight - angled
22262066	AB-C4-M12MS-5,0PUR-M12FA	5	straight - angled
22260969	AB-C4-M12MS-6,0PUR-M12FA	6	straight - angled
22260851	AB-C4-M12MS-10,0PUR-M12FA	10	straight - angled

Additional note

Data sheet also valid for variant lengths. Other lengths on request.

Electrical properties

Rated voltage	250 V
Rated current	4 A
Overvoltage category	II
Pollution degree	3

Mechanical properties

Plug, jack

Inflammability class in accordance with UL 94	HB
Contact, material	CuSn
Contact carrier, material	TPU GF
Contact surface, material	Ni/Au
Knurl, material	Zinc diecasting, nickel-plated
Handle, material	TPU, flame retardant, self-extinguishing
Sealing, material	NBR

Creator: THLE3/PDP Released: IVSE1/PDP	Document: DB22260332EN Version: 06	Page 1 of 3
---	---------------------------------------	-------------

22260332	DATA SHEET	
Valid from: 21.12.2023	AB-C4-M12MS-(L*)PUR-M12FA	

Line

Cable construction	4 x AWG22/42
Signal line, construction	42 x 0,1 mm
Conductor cross-section	0,34 mm ²
Conductor diameter including isolation	1,27 mm ± 0,02 mm
Cable outer diameter	4,7 mm ± 0,15mm
Insulation color	brown, white, blue, black
Sheath color	grey-black, RAL 7021
Number of bending cycles	10.000.000
Traveling distance	10 m
Traveling speed	3 m/s
Acceleration	10 m/s ²
Cable weight	30 kg/km
Outer coating, material	PUR
Wire insulation, material	PP
Insulation resistance	≥ 1 GΩ*km
Conductor resistance	≤ 58 Ω/km
Flame resistance	acc. to UL 758 / 1581 FT2 DIN EN 60332-2-2 (20 s)
Halogen-free	acc. to DIN VDE 0472 Part 815 DIN EN 50267-2-1
Oil resistance	acc. to DIN EN 60811-2-1
Other resistances	resistant to hydrolysis and microbes good resistant to acids, lyes and solvents limited UV resistance acc. to DIN EN ISO 4892-2-A low adhesion abrasion resistant

Standards

Product standard, M12 connector	IEC 61076-2-101
UL-Listed, E-File	E249137

Creator: THLE3/PDP Released: IVSE1/PDP	Document: DB22260332EN Version: 06	Page 2 of 3
---	---------------------------------------	-------------

22260332	DATA SHEET	
Valid from: 21.12.2023	AB-C4-M12MS-(L*)PUR-M12FA	

Technical drawing

Dimensional drawing

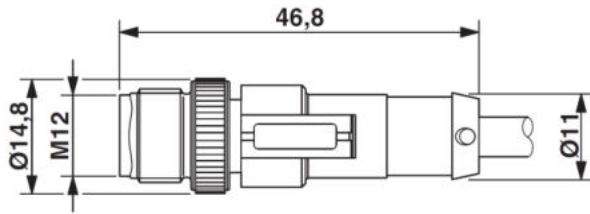

Plug M12 x 1, straight

Dimensional drawing

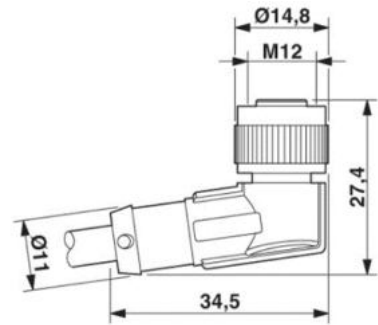

Jack M12 x 1, angled

Drawing

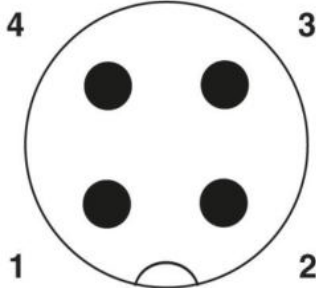

Pin assignment M12-plug, 4-pol, A-coding

Drawing

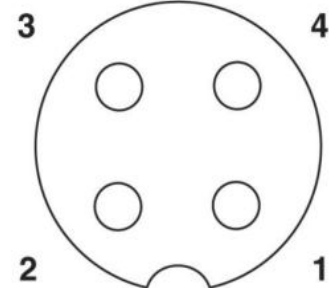

Pin assignment M12-jack, 4-pol, A-coding

Circuit diagram

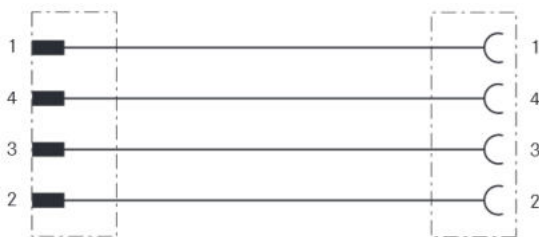

Pin assignment between M12-plug and M12-jack

Wire cross section

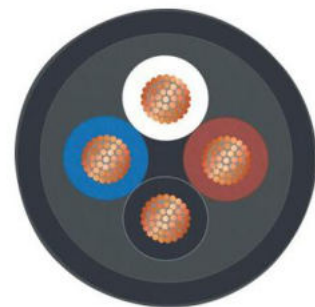

Application range

For increased mechanical load and rough operating conditions

Note

Photographs are not true to scale and do not represent detailed images of the respective products.

Creator: THLE3/PDP Released: IVSE1/PDP	Document: DB22260332EN Version: 06	Page 3 of 3
---	---------------------------------------	-------------