

52106410	DATA SHEET	
Valid from: 05.02.2025	SKINDICHT® SR-M	

The SKINDICHT® SR-M is a special cable gland with metric connecting thread to meet maximum demands on strain-relief, sealing and kink-protection. The neoprene sleeve works in two ways. It provides sealing and protection against kinking. Strain-relief is achieved by a solid brass cleat.



Components:

Gland body	Brass, nickel-plated
Pressure clamping with cleat	Brass, nickel-plated
Thread screws	Brass, nickel-plated
Anti-kink sleeve	CR
Pressure washer	Steel, zinc-plated
O-ring	NBR

Technical features:

Connecting thread	M12x1,5 up to M63x1,5 acc. to EN 60423
Protection class	IP65 acc. to EN 60529
Temperature range	-20 °C up to +80 °C

Norm references:



The protection rate IP65 is achieved in case of correct installation.
The locating surface shall be clean and flat. The installation thread shall correspond with EN 60423.

Creator: T. Dvoulety/PDP Released: DAMU1/PDP	Document: DB52106410EN Version: 06	Page 1 of 2
---	---------------------------------------	-------------

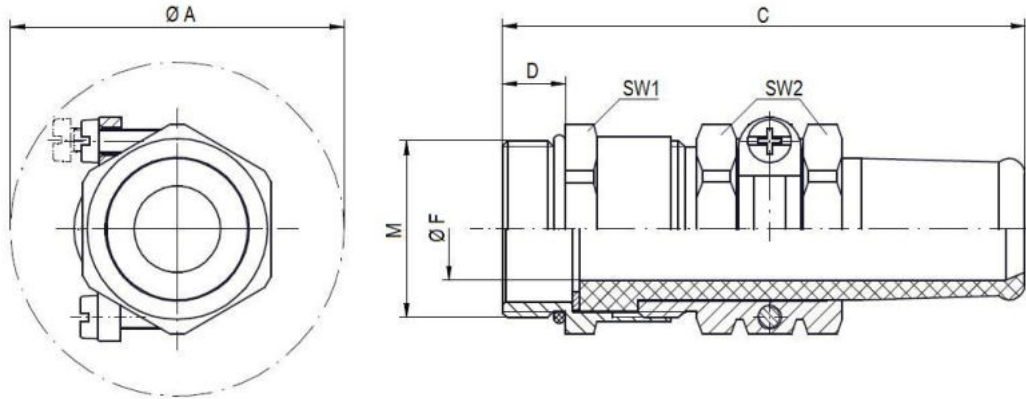

M	SW1 [mm]	SW2 [mm]	Ø A [mm]	C [mm]	D [mm]	Ø F [mm] Clamping range	O-Ring [mm]	Article No.
M12x1,5	14	15	23	49,0	5	4-5	9x1,5	52106410
M16x1,5	18	17	25	50,0	5	5,5-7	13x1,5	52106420
M20x1,5	22	20	28	55,0	6	5,5-7	17x1,5	52106430
M20x1,5	22	20	28	55,0	6	7,5-9	17x1,5	52106440
M20x1,5	22	22	32	60,0	6	7,5-9	17x1,5	52106450
M20x1,5	22	22	32	60,0	6	9-11	17x1,5	52106460
M20x1,5	22	22	32	60,0	6	11-13	17x1,5	52106470
M20x1,5	24	24	35	65,0	6	12-13	17x1,5	52106480
M20x1,5	24	24	35	65,0	6	14 - 15	17x1,5	52106481
M25x1,5	30	30	46	78,5	7	12,5-15	22x2	52106490
M25x1,5	30	30	46	78,5	7	14-17	22x2	52106500
M25x1,5	30	30	46	78,5	7	17-19	22x2	52106510
M25x1,5	30	30	46	78,5	7	17-20	22x2	52106520
M32x1,5	40	41	59	90,5	8	19-20	28x2	52106530
M32x1,5	40	41	59	90,5	8	22-23	28x2	52106540
M32x1,5	40	41	59	90,5	8	23-25	28x2	52106550
M40x1,5	50	50	70	108,0	8	24-26	36x2	52106560
M40x1,5	50	50	70	108,0	8	28-30	36x2	52106570
M40x1,5	50	50	70	108,0	8	31-33	36x2	52106580
M40x1,5	50	50	70	108,0	8	33-34,5	36x2	52106590
M50x1,5	57	57	75	111,0	9	31-34,5	46x2	52106600
M50x1,5	57	57	75	111,0	9	32-38	46x2	52106610
M50x1,5	57	57	75	111,0	9	37-40	46x2	52106620
M63x1,5	66	64	83	118,0	10	32-40	57x2	52106630
M63x1,5	66	64	83	118,0	10	36-44	57x2	52106640

For more information please see our current catalogue. Please do not hesitate to contact our laboratory if there are any questions regarding resistance against aggressive agents and special oil.