

22260842	<b>DATA SHEET</b>	
Valid from: 26.01.2024	<b>AB-C4-(L*)PVC-M12FA</b>	

## Product description

- Sensor/actuator cable, 4-pol, PVC black
- Angled M12-jack on free conductor end



## General characteristics

Number of pins	4
Ambient temperature	-25 °C to +90 °C (-13°F to 194°F) (plug / jack) -25 °C to +80 °C (-13°F to 176°F) (cable, fixed installation) -10 °C to +80 °C (14°F to 176°F) (cable, movable installation)
Degree of protection	IP65 / IP67 / IP68
Coding	A-standard
Tightening torque	0,4 Nm (M12-connector)
Plugging cycles	≥ 100

## Variation

Article number	Description	Length [m]	Configuration
22260842	AB-C4-1,0PVC-M12FA	1	angled
22260841	AB-C4-2,0PVC-M12FA	2	angled
22260840	AB-C4-3,0PVC-M12FA	3	angled
22260843	AB-C4-4,0PVC-M12FA	4	angled
22260678	AB-C4-5,0PVC-M12FA	5	angled
22260836	AB-C4-6,0PVC-M12FA	6	angled
22260838	AB-C4-7,0PVC-M12FA	7	angled
22260839	AB-C4-8,0PVC-M12FA	8	angled
22260679	AB-C4-9,0PVC-M12FA	9	angled
22260683	AB-C4-10,0PVC-M12FA	10	angled
22260917	AB-C4-20,0PVC-M12FA	20	angled
22261102	AB-C4-25,0PVC-M12FA	25	angled
22262087	AB-C4-30,0PVC-M12FA	30	angled
22261106	AB-C4-35,0PVC-M12FA	35	angled

## Additional note

Data sheet also valid for variant lengths. Other lengths on request.

## Electrical properties

Rated voltage	250 V
Rated current	4 A
Overvoltage category	II
Pollution degree	3

Creator: THLE3/PDP Released: IVSE1/PDP	Document: DB22260842EN Version: 06	Page 1 of 3
---	---------------------------------------	-------------

22260842	<b>DATA SHEET</b>	
Valid from: 26.01.2024	<b>AB-C4-(L*)PVC-M12FA</b>	

## Mechanical properties

### Jack

Inflammability class in accordance with UL 94	HB
Contact, material	CuSn
Contact carrier, material	TPU GF
Contact surface, material	Ni/Au
Knurl, material	Zinc diecasting, nickel-plated
Handle, material	TPU, flame retardant, self-extinguishing
Steal, material	NBR

### Line

Cable construction	4 x AWG22/42
Signal line, construction	42 x 0,1 mm
Conductor cross-section	0,34 mm <sup>2</sup>
Conductor diameter including isolation	1,26 mm ± 0,05 mm
Cable outer diameter D	5,2 mm ± 0,15mm
Insulation color	brown, white, blue, black
Sheath color	black RAL 9005
Minimum bending radius, fixed	5 x D
Minimum bending radius, movable installation	10 x D
Cable weight	40 kg/km
Outer coating, material	PVC
Wire insulation, material	PVC
Insulation resistance	≥ 200 MΩ*km (at 20 °C)
Conductor resistance	max. 57 Ω/km (at 20 °C)
Flame resistance	acc. to UL-Style 2464
Oil resistance	acc. to DIN EN 60811-2-1, 168 h at 60 °C

## Standards/Approvals

Product standard, M12 connector	IEC 61076-2-101
UL-Listed, E-File	E249137

Creator: THLE3/PDP Released: IVSE1/PDP	Document: DB22260842EN Version: 06	Page 2 of 3
---	---------------------------------------	-------------

22260842	<b>DATA SHEET</b>	
Valid from: 26.01.2024	AB-C4-(L*)PVC-M12FA	

### Technical drawing

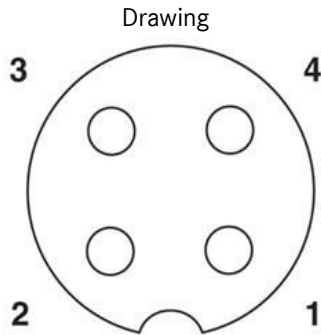

Pin assignment M12-jack, 4-pol, A-coding

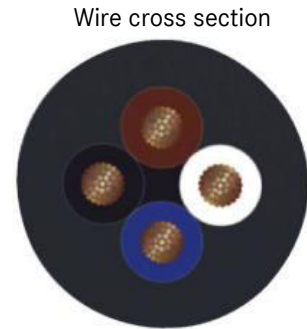

Circuit drawing

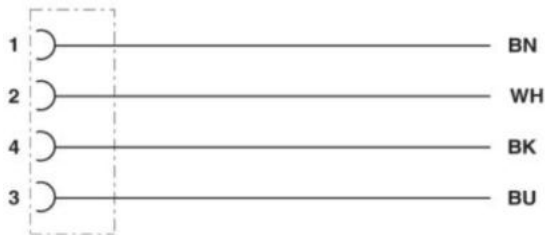

Pin assignment M12-jack

Dimensional drawing

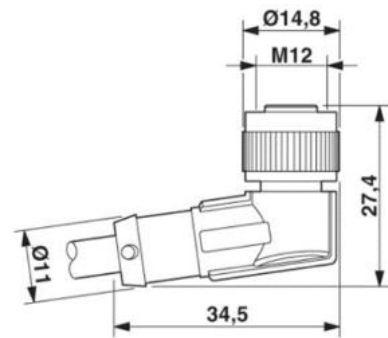

Jack M12 x 1, angled

### Application range

For medium mechanical load in dry areas

### Note

Photographs are not true to scale and do not represent detailed images of the respective products.

Creator: THLE3/PDP Released: IVSE1/PDP	Document: DB22260842EN Version: 06	Page 3 of 3
---	---------------------------------------	-------------