

22260007	<b>DATA SHEET</b>	
Valid from: 17.09.2018	<b>AB-B8-M12-8-C</b>	

## Description

- Sensor/actuator box
- Connection methods: quick locking without LED pluggable master cable connection and single-occupied slots
- slots: 8



Number of slots:	8
Nominal voltage U <sub>N</sub> :	120 V
Max. current carrying capacity per path:	2 A
Total current:	1x10 A
Total rated current (for electrical isolation):	2x8 A
Connection type:	pluggable master cable connection
Current carrying capacity per slot:	4 A
Number of poles:	4
Degree of protection:	IP65/IP67/IP69K
Status display:	no
Inflammability class acc. to UL 94:	V0
Contact surface material:	Gold-plated
Material, O-ring:	NBR
Material of the moulding mass:	PUR
Material of threaded sleeve:	Zinc die-cast
Material of threaded sleeve surface:	Nickel-plated
Tightening torque slot sensor/actuator cable:	0.4 Nm
Tightening torque screw plug:	0.4 Nm

## Conductor data

Slot/position = Wire colour or connection: 1 / 4 (A) = 1 / 4

Creator: FELI1/PDP Released: IVSE1/PDP	Document: DB22260007EN Version: 04	Page 1 of 3
---	---------------------------------------	-------------

22260007	<b>DATA SHEET</b>	
Valid from: 17.09.2018	AB-B8-M12-8-C	

**Technical drawing**

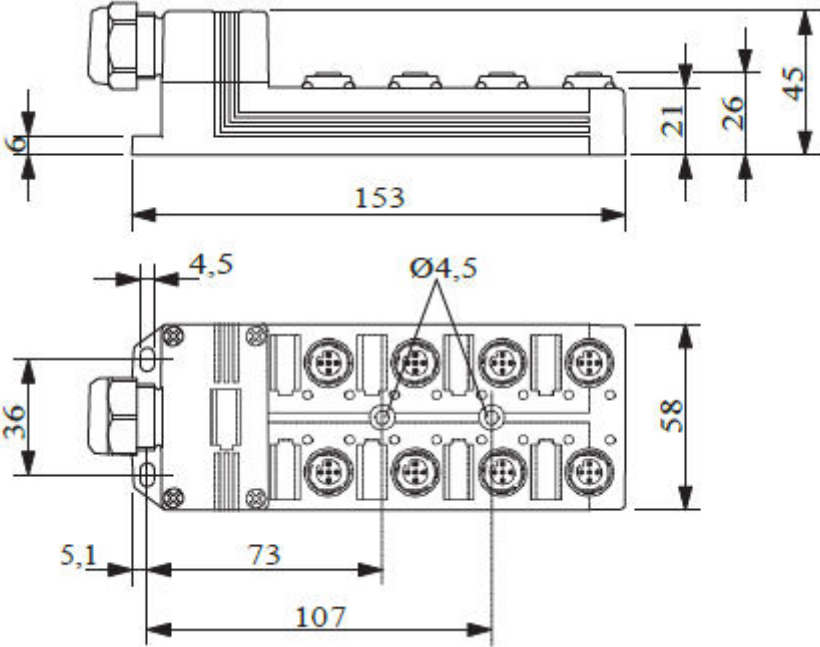

**Circuit diagram**

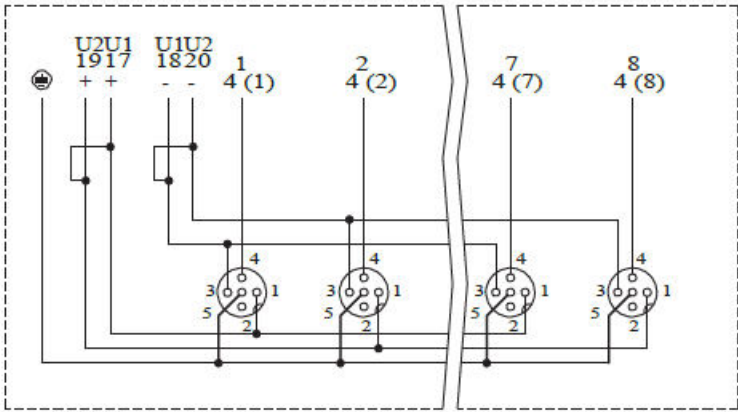

**Example:**

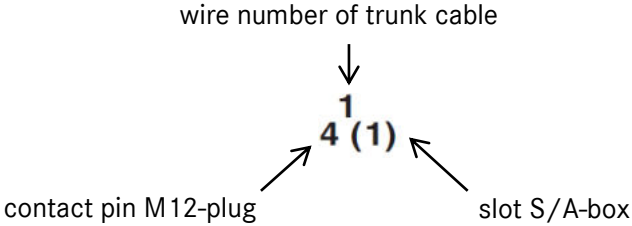

22260007	<b>DATA SHEET</b>	
Valid from: 17.09.2018	<b>AB-B8-M12-8-C</b>	

### Schema drawings

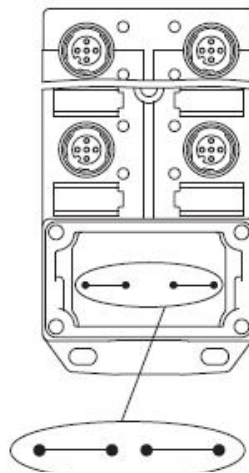
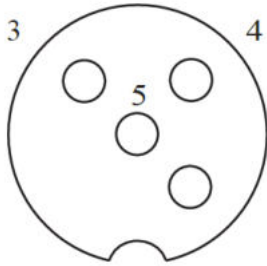

Potential  $U_{N1}$  and  $U_{N2}$  joint.  
Potential order:  
 $U_{N1} = U_{N2} =$  slots 1,2,3,4

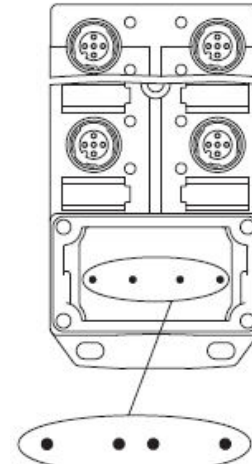

Potential separated. Potential order:  
 $U_{N1} =$  slots 1, 3 and  
 $U_{N2} =$  slots 2, 4

### Pin assignment

Slot/ position = Wire color or connection

- 1 / 4 (A) = WH
- 2 / 4 (A) = GN
- 3 / 4 (A) = YE
- 4 / 4 (A) = GY
- 5 / 4 (A) = PK
- 6 / 4 (A) = RD
- 7 / 4 (A) = BK
- 8 / 4 (A) = VT
- 1-8 / 1 (+ 120 V) = BN
- 1-8 / 3 (0 V) = BU
- 1-8 / 5 (PE) = GN/YE

### Application range

Automation, industrial machinery and plant engineering

### Note

Photographs are not true to scale and do not represent detailed images of the respective products.

Creator: FELI1/PDP Released: IVSE1/PDP	Document: DB22260007EN Version: 04	Page 3 of 3
---	---------------------------------------	-------------